



✉ info@ebrarhirdavat.com

🏠 Ferhatpaşa-Ataşehir / İSTANBUL

☎ 0216 312 92 22

🌐 www.ebrarhirdavat.com  
katalog.ebrarhirdavat.com

2020



## EMİN ADIMLAR İLE HİZMETİNİZDE



Ebrar Hırdavat 2008 yılı kuruluşundan günümüze, hergün gelişen ve yükselen bünyesi ile siz iş ortaklarımıza sektörde hizmet vermeye devam etmektedir.

2020 yılı itibari ile taşınmış olduğumuz yeni tesisimizde, çeşitli ürünlerin üretimi, stoklarımızda mevcut geniş ürün yelpazesi, deneyimli yöneticileri ve tecrübeli personeli ile sizlerle birlikte sektörde varlığını sürdürmeye devam edecektir.



## SATIŞ SORUMLULARI



Muammer BİLGİLİ



0541 590 58 28



bilgili@ebrarhirdavat.com



Musa LAFÇI



0544 590 23 93



lafci@ebrarhirdavat.com



Fatih Mehmet BİLGİN



0541 590 24 58



bilgin@ebrarhirdavat.com



### EBRAR HIRDAVAT YAPI MALZEMELERİ



Ferhatpaşa Mahallesi, Gazipaşa Caddesi, No:11/1 Ataşehir / İSTANBUL



0216 312 92 22



www.ebrarhirdavat.com



info@ebrarhirdavat.com



## YAPIŐTIRICILAR VE KİMYASALLAR

- \* SİLİKON
- \* MASTİK
- \* KÖPÜK
- \* HIZLI YAPIŐTIRICI - MDF KIT
- \* 502 HIZLI YAPIŐTIRICI
- \* DENİZ TUTKALI
- \* SIVI CONTA
- \* MERMER YAPIŐTIRICI
- \* BALLY

- \* KALIP AYIRICI
- \* BALATA TEMİZLEYİCİ
- \* SPREY BOYA
- \* MUM SİLİKON
- \* LAVABO AÇICI
- \* KOLİ KALEMİ
- \* DAKSİL

SAYFA 8-21

## BANT ÜRÜNLERİ

- \* KOLİ BANDI (AKRLİK - HOTMELT)
- \* MASKELME BANDI
- \* ÇİFT TARAFLI BANT
- \* ÇİFT TARAFLI KÖPÜK BANT
- \* ÇİFT TARAFLI AKRLİK VHB BANT
- \* ALÜMİNYUM FOLYO BANT
- \* DERZ BANDI

- \* TEFLON BANT
- \* ÇOK AMAÇLI BANT
- \* İKAZ BANDI
- \* MERDİVEN KAYDIRMAZ BANT
- \* STREÇ
- \* KAPI PENCERE BANDI

SAYFA 24-31

## KESİCİ-DELİCİ-AŐINDIRICI

- \* MATKAP UCU
- \* MURÇ - KESKİ
- \* BİTS UÇ
- \* SOMUN ADAPTÖRÜ
- \* DEMİR TESTERE AĐIZI
- \* DEKUPAJ TESTERE BIÇAĐI
- \* PANÇ
- \* SUNTA KESME TESTERESİ
- \* TURBO ELMAŐ KESİCİ
- \* MAKET BIÇAĐI - AĐIZI
- \* TESTERE
- \* EĐE

- \* TEL FIRÇA
- \* SU ZIMPARASI
- \* CİRT ZIMPARA
- \* RULO ZIMPARA
- \* FLAP DİSK
- \* FİBER DİSK
- \* METAL KESME
- \* DÖKÜM KESME
- \* İNOX KESİCİ
- \* TAŐLAMA TAŐI
- \* SÜNGER ZIMPARA

SAYFA 34-53



## EL ALETLERİ

- \* PENSE
- \* FORT PENSE
- \* AYARLI PENSE
- \* YANKESKİ
- \* KARGABURUN
- \* KERPETEN
- \* KURBAĞACIK
- \* TORNAVİDA
- \* ALLEN ANAHTAR
- \* ANAHTAR TAKIMI
- \* ÇEKİÇ
- \* LASTİK TOKMAK
- \* KESER
- \* KAYNAK MAKİNASI
- \* BORU MAKASI
- \* BOYA TABANCASI
- \* HAVA TABANCASI
- \* SİRİRAL HAVA HORTUMU
- \* MANDREN ANAHTARI
- \* MAŞALI BORU ANAHTARI
- \* MUM SİLİKON TABANCASI
- \* METRE
- \* SU TERAZİSİ
- \* MANDREN
- \* MAKARALI KABLO
- \* KOLLU MAKAS
- \* YAĞDANLIK

SAYFA 56-66

## MOBİLYA AKSESUARLARI VE KİLİT

- \* KALE KİLİT
- \* YUMA KİLİT
- \* TOPUZLU KİLİT
- \* KAPI KOLU
- \* ASPİRATÖR BORUSU
- \* KAPI TAMPONU - STOPERİ
- \* GÖNYE
- \* RAF ALTI
- \* ALÜMİNYUM CAM KAPI EMNİYET APARATI
- \* DEMİR DOĞRAMA SÜRGÜSÜ
- \* YAYLI SÜRGÜ
- \* MAVZER SÜRGÜ
- \* SANDIK ASKISI
- \* YAPRAK MENTEŞE
- \* PVC EMNİYET KİLİDİ
- \* PİTON
- \* ÇEKMECE KİLİDİ

SAYFA 70-86

## BAĞLANTI ELEMANLARI

- \* VİDA
- \* GİJON
- \* ÇELİK DÜBEL
- \* MADE ÜRÜNLERİ
- \* CIRT PLASTİK KELEPÇE
- \* HORTUM KELEPÇESİ
- \* ÇİROZ - KOLU
- \* İSKELE KELEPÇESİ

SAYFA 88-93

## NALBURIYE ÜRÜNLER

- \* KÜREK
- \* BALTA - NACAK
- \* ÇAPA
- \* KAZMA
- \* TIRMIK
- \* BALYOZ
- \* METAL UZATMALI SAP
- \* AHŞAP SAP
- \* EL ARABASI
- \* EL ARABASI TEKERİ
- \* SIVA FİLESİ
- \* SIVA SÜNGERİ
- \* ÇUVAL
- \* MERDVEN
- \* MENFEZ
- \* PUNTALI TEL

- \* TESTERE KOLU
- \* USTA KALEMİ
- \* KAPI İTME YAYI
- \* PİMAPEN KOLU
- \* HALAT
- \* İP
- \* BRANDA
- \* FIRÇA
- \* KANAL AÇMA TELİ
- \* ÇAMAŞIR ASKISI
- \* ÇİVİ - ÖNLÜK
- \* İNŞAAT TELİ
- \* ŞALÜMO - PÜR MÜZ
- \* KARTUJ TABANCA

**SAYFA 96-120**

## İNŞAAT VE DEKORASYON

- \* DEKOR - HASSAN ÜRÜNLERİ
- \* SERFA ÜRÜNLERİ
- \* RULO
- \* FIRÇA
- \* KESTİRME FIRÇA
- \* BOYA KARIŞTIRICI

**SAYFA 122-134**

## İŞ GÜVENLİĞİ

- \* İŞ AYAKKABISI
- \* ÇİZME
- \* BOT
- \* İKAZ YELEĞİ
- \* YAĞMURLUK
- \* BARET
- \* EMNİYET KEMERİ
- \* ALAN PERDESİ

- \* TOZ MASKESİ
- \* ELDİVEN
- \* KAYNAK MASKESİ
- \* GÖZLÜK
- \* KAYNAK PENSESİ
- \* ŞASE PENSESİ

**SAYFA 136-148**

## KALDIRMA EKİPMANLARI

- \* KRİKO
- \* CERASKAL
- \* TRANSPALET
- \* ARABALI KRİKO

SAYFA 150

## ELEKTRİKLİ EL ALETLERİ

- \* MAX EXTRA
- \* ROWN

SAYFA 152-159

## GENEL SATIŞ ŞARTLARIMIZ

- \* Fiyatlarımıza KDV dahil değildir.
- \* Kredi kartı ve peşin ödemeli satışlar 7 gün içinde kapatılmalıdır.
- \* Vadeli hesaplar en geç 30 gün içinde kapatılmalıdır.
- \* Yıl sonu itibari ile cari hesapların sıfırlanması gerekmektedir.
- \* Elde olmayan sebepler ile siparişin tamamının gönderilmemesi durumunda müşteri herhangi bir hak iddia edemez.
- \* Firmamızın katalogtaki fiyatları ve satış sirkülerindeki şartların bazılarını veya tamamını değiştirme hakkı mahfuzdur.
- \* İade ürün ambalajı sağlam olmak kaydıyla 15 gün içinde satış temsilcisinin bilgisi dahilinde kabul edilir.



### GENEL AMAÇLI SİLİKON 280 gr

KOD	ÜRÜN ADI	KOLİ	BİRİM	FİYAT
01.06.116	ŞEFFAF	30	AD	1,91 €
01.06.117	BEYAZ	30	AD	1,91 €
01.06.066	GRİ	30	AD	2,26 €
01.06.068	SİYAH	30	AD	2,26 €
01.06.133	KAHVE	30	AD	2,13 €

- \* ASETOKSİ KÜRLEŞME SİSTEMİNE SAHİPTİR.
- \* DİK DÜZEYLERDE AKMA YAPMAZ.
- \* KURUDUĞUNDA SU GEÇİRMEZ BARIYER OLUŞTURUR.
- \* NEM VE KÜF OLUŞUMUNU YAVAŞLATAN KATKI MALZEMELERİ İÇERİR.
- \* İÇ VE DIŞ MEKANLARDA KULLANILABİLİR.
- \* SICAKLIK DEĞİŞİMLERİNE VE HAVA KOŞULLARINA DAYANIKLIDIR.



### GENEL AMAÇLI MASTİK

KOD	ÜRÜN ADI	KOLİ	BİRİM	FİYAT
01.06.069	BEYAZ	30	AD	0,92 €
01.06.128	GRİ	12	AD	0,94 €
01.06.078	KREM	12	AD	1,05 €
01.06.103	A.MEŞE	12	AD	1,00 €
01.06.071	SİYAH	12	AD	1,00 €
01.06.070	KAHVE	12	AD	1,00 €

- \* KULLANIMA HAZIR TEK KOMPONENTLİ DOLGU MALZEMESİ
- \* BETON, TUĞLA, METAL VE AHŞAP GİBİ MALZEMELERDE BOŞLUK DOLDURMAYA YARAR.
- \* ÜZERİ BOYANABİLİR.
- \* SOLVENT İÇERMEZ, KOKUSUZDUR.

## PU SIVI ÇİVİ

KOD	ÜRÜN ADI	KOLİ	BİRİM	FİYAT
01.05.063	280 ml	12	AD	4,21 €

- \* BOŞLUK DOLDURMA ÖZELLİĞİNE SAHİP, HIZLI KURUYAN POLİÜRETAN MONTAJ YAPIŞTIRICISI.
- \* AHŞAP, PVC, FAYANS, CAM VE BETON ÜZERİNDE ÇOK GÜÇLÜ YAPIŞIR.
- \* ÇOK HIZLI KURUR, PRESLEME SÜRESİ KISADIR.
- \* NEME VE SUYA DAYANIKLIDIR.
- \* JEL KIVAMINDADIR.
- \* DİK YÜZEYLERDE AKMA YAPMAZ.
- \* YAPIŞTIRILACAK YÜZEYLERE YAYILMALI VE İNCE BİR TABAKA OLARAK UYGULANMALIDIR.



## RTV ISI SİLİKONU KIRMIZI

KOD	ÜRÜN ADI	KOLİ	BİRİM	FİYAT
01.05.061	280 ml	12	AD	3,96 €

- \* CAM, FAYANS VE METAL BENZERİ GOZENEKSİZ YÜZEYLERE ÇOK GÜÇLÜ YAPIŞIR.
- \* %100 SAF SİLİKONDUR.
- \* UÇUCU ORGANİK YAĞLAR İÇERMEZ VE HACİM KAYBINA UĞRAMAZ.
- \* SÜREKLİ 250°C VE 300°C SICAKLIKLARA MARUZ KALDIĞINDA ÖZELLİKLERİNİ KAYBETMEZ.
- \* UYGULAMA YERİNDE SÜREKLİ ESNEK VE ÇATLAMAYA DİRENÇLİ CONTA OLUŞTURARAK HAZIR CONTALARIN YERİNİ ALABİLİR.
- \* DAYANIKLILIĞI ARTTIRMAK İÇİN HAZIR CONTALARIN ÜZERİNE UYGULANABİLİR.
- \* KİMYASALLARA YAĞLARA VE SOLVENTLERE KARŞI DAYANIKLIDIR.

## AYNA SİLİKONU

KOD	ÜRÜN ADI	KOLİ	BİRİM	FİYAT
01.05.060	280 ml	12	AD	4,06 €

- \* AYNA YAPIŞTIRMA UYGULAMALARI İÇİN DİZAYN EDİLMİŞ HIZLI KURUYAN, NÖTR SİLİKON BAZLI YAPIŞTIRICI.
- \* AYNA MONTAJINDA VE PENCERE ÇERÇEVESİ ETRAFINDA SIZDIRMAZLIK UYGULAMALARINDA KULLANILIR.
- \* CAM, AHŞAP, METAL VE BETON ÜZERİNE GÜÇLÜ YAPIŞIR.
- \* AYNA ÜZERİNDE KOROZYONA NEDEN OLMAZ.
- \* ÇOK HIZLI KURUR.
- \* SAF SİLİKONDUR, HACİM KAYBINA UĞRAMAZ.



## AKVARYUM SİLİKONU

KOD	ÜRÜN ADI	KOLİ	BİRİM	FİYAT
01.05.059	280 ml	12	AD	3,82 €

- \* AKVARYUM MONTAJI VE CAM ÜZERİNDE SIZDIRMAZLIK İŞLERİ İÇİN FORMÜLE ESİLMİŞ MÜKEMMEL YAPIŞAN SİLİKON.
- \* AKVARYUM İMALATINDA, CAM MALZEMELERİ YAPIŞTIRILMASINDA, CAM VİTRİN MONTAJINDA KULLANILIR.
- \* %100 SİLİKONDUR. SOLVENT İÇERMEZ, HACİM KAYBINA UĞRAMAZ.
- \* AKVARYUM CANLILARINA ZARAR VEREBİLECEK KİMYASALLAR İÇERMEZ.
- \* HIZLI KÜRLEŞİR.
- \* UYGULAMA SONRASI SAATLER İÇERİSİNDE SU GEÇİRMEZ FORMA
- \* MEKANİK DAYANIMI YÜKSEKTİR.



## GENEL AMAÇLI KÖPÜK

KOD	ÜRÜN ADI	KOLİ	BİRİM	FİYAT
01.03.001	600 gr	16	AD	2,83 €
01.05.67	750 ml	16	AD	4,52 €

- \* KONTROLLÜ BÜYÜR.
- \* HIZLI KURUR.
- \* YÜKSEK VERİM VERİR.
- \* YALITIM DEĞERİ YÜKSEKTİR.
- \* YARI ESNEK YAPIDADIR.
- \* PENCERE KASALARINI ÇEVRELEYEN BOŞLUKLARIN DOLDURULMASINDA BİNALARDAKİ DELİK ÇATLAK VE BOŞLUK İZOLASYON AMAÇLI DOLDURULMASINDA KULLANILIR.



## DENİZ TUTKALI

KOD	ÜRÜN ADI	KOLİ	BİRİM	FİYAT
01.05.057	280 ml	6	AD	3,98 €

- \* POLİÜRETAN BAZLI SUYA DAYANIKLI VE NEME DAYANIKLI, BOŞLUK DOLDURMA ÖZELLİĞİNE SAHİP YAPIŞTIRICIDIR.
- \* AHŞAP, BETON, VE METAL YÜZEYLERE GÜÇLÜ YAPIŞIR.
- \* MOBİLYA İMALATINDA VE TAMİRİNDE HEMEN HER TÜRLÜ AHŞABI BİRBİRİNE, METALE, TAŞ, TUĞLA VE BETONA YAPIŞTIRMADA KULLANILIR.
- \* İÇ VE DIŞ MEKANLARDA KULLANIMA UYGUN.
- \* SINIRLI BÜYÜME YAPAR, BOŞLUK DOLDURUR.
- \* SUYA, RUTUBETE VE HAVA ŞARTLARINA SON DERECE DAYANIKLIDIR

### HIZLI YAPIŖTIRICI

KOD	ÜRÜN ADI	KOLİ	BİRİM	FİYAT
01.05.001	200 ml	50	AD	1,32 €
01.05.002	400 ml	25	AD	2,45 €

- \* AHŖAP PARÇALARIN MONTAJ VE TAMİRATINDA, MDF, KAUÇUK, DERİ, PLASTİK YÜZEYLERDE VE HIZLI YAPIŖMA İSTENEN HER YERDE UYGULANABİLİR.
- \* YAPIŖTIRILACAK YÜZEYLERİ TOZ, KİR VE YAĞDAN TEMİZLEDİKTEN SONRA YÜZEYLERDEN BİRİNE YAPIŖTIRICI DİĞERİNE İSE AKTİVATÖR SIKILDIKTAN SONRA YÜZEYLER BİRLEŖTİRİLİP BİR KAÇ SANİYE KUVVETLİCE BASINÇ UYGULANIR.



### SIVI CONTA

KOD	ÜRÜN ADI	KOLİ	BİRİM	FİYAT
01.07.086	KIRMIZI 50 ml	36	AD	2,33 €
01.07.087	SİYAH 50 ml	36	AD	2,33 €

## TÜP SİLİKON

KOD	ÜRÜN ADI	KOLİ	BİRİM	FİYAT
01.06.091	50 gr	36	AD	1,15 €







### TYTAN LEXY 60 KÖPÜK

KOD	ÜRÜN ADI	KOLİ	BİRİM	FİYAT
01.03.029	830 ml	12	AD	5,62 €

Yeni geliştirilmiş poliüretan köpük, çok yüksek hacim ve üstün hücre yapısına, modern teknolojiyle. Ürün, çok konumlu fonksiyonu sayesinde, zor alanlarda bile yalıtım, doldurma, izole etme ve montajda önerilir. (teneke sıcaklığı >15°C).

### TYTAN STYRO 753

KOD	ÜRÜN ADI	KOLİ	BİRİM	FİYAT
01.11.006	750 ml	16	AD	5,90 €

Tytan Professional O2 STYRO 753 Yapıştırıcı, dış cephe izolasyonunda, EPS ve XPS levhaların dış cepheye, çatıya ve zeminlere yapıştırılması için geliştirilmiştir. Özellikle dış cephe ısı yalıtım sistemlerinde ( ETICS) kullanılan tüm polistiren yalıtım levhaları ile uyumludur. Birçok yüzey uyumu ve elastikiyet özelliği güçlü yapışmayı sağlamaktadır.



### TYTAN POLYFIX PLUS

KOD	ÜRÜN ADI	KOLİ	BİRİM	FİYAT
01.06.100	750 ml	12	AD	4,60 €



Özellikle iç kapı montaj işlerinde kullanılır. Şişem yapmaz. Tekrar tekrar kullanılabilen, Emniyet Valfli PU Köpük. Yüksek her türlü inşaat malzemesine yapışan ve yalıtan, kullanıma hazır PU köpük. Genişleme sırasında çatlak şeklini alır, doldurur. Köpük kuruduktan sonra kesilebilir.





### TYTAN POLYFIX COMBO

KOD	ÜRÜN ADI	KOLİ	BİRİM	FİYAT
01.06.140	750 ml	12	AD	4,50 €

Yüksek kaliteli, her türlü inşaat malzemesini yapıştıran ve yalıtan, kullanıma hazır PU köpük. Genişleme sırasında çatlak şeklini alır, doldurur. Köpük kuruduktan sonra kesilebilir, zımparalanabilir ve boyanabilir



### WD-40 PAS SÖKÜCÜ ve YAĞLYICI

KOD	ÜRÜN ADI	KOLİ	BİRİM	FİYAT
01.06.094	200 ml	36	AD	
01.06.095	350 ml	24	AD	



### GRANİT MERMER VE TAŞ YAPIŞTIRICI

KOD	ÜRÜN ADI	KOLİ	BİRİM	FİYAT
01.06.001	250 gr	24	AD	2,22 \$
01.06.002	500 gr	12	AD	3,18 \$
01.06.003	1000 gr	12	AD	4,52 \$
01.06.004	1200 gr	12	AD	5,20 \$



### KİMYASAL DÜBEL

KOD	ÜRÜN ADI	KOLİ	BİRİM	FİYAT
01.02.001	345 ml	12	AD	4,50 \$
01.02.009	410 ml	12	AD	5,36 \$



### BEYAZ TUTKAL

KOD	ÜRÜN	KOLİ	BİRİM	FİYAT
01.13.001	100 gr	20	AD	3,36 ₺
01.13.002	350 gr	12	AD	8,40 ₺
01.13.003	700 gr	12	AD	14,40 ₺
01.13.004	200 gr	24	AD	4,80 ₺



### BALLY KIRMIZI

KOD	ÜRÜN ADI	KOLİ	BİRİM	FİYAT
B-01.01.006	50 gr	100	AD	1,30 \$
B-01.01.005	150 gr	50	AD	3,56 \$
B-01.01.007	250 gr	48	AD	4,45 \$
B-01.01.008	500 gr	40	AD	9,00 \$
B-01.01.009	1000 gr	20	AD	16,01 \$
B-01.01.010	GALON	6	AD	34,06 \$



### BEST KALIP AYIRICI 400 ml

KOD	ÜRÜN	KOLİ	BİRİM	FİYAT
01.07.067	KA 1000	20	AD	25,67 ₺
01.07.066	KA 2000	20	AD	23,02 ₺
01.07.068	KA 571 SİLİKONSUZ	20	AD	27,63 ₺

### BEST BALATA TEMİZLEYİCİ

KOD	ÜRÜN	KOLİ	BİRİM	FİYAT
01.07.063	CR 1001	24	AD	16,96 ₺





**250 ML  
13,55 ₺**

**400 ML  
29,00 ₺**





**EFEKT**  
**400 ML**  
**43,91 ₺**

**P.ALTIN**  
**400 ML**  
**37,86 ₺**



### BEST VERNİK

KOD	ÜRÜN	KOLİ	BİRİM	FİYAT
01.03.024	250 ml	30	AD	20,23 ₺
01.07.062	SELÜLOZİK 300 ml	12	AD	27,80 ₺

### BEST SIVI GRES

KOD	ÜRÜN	KOLİ	BİRİM	FİYAT
01.07.064	LU 500	12	AD	22,41 ₺
01.07.065	LU 1000 KAUCUK	12	AD	22,41 ₺

### BEST GAZ ALTI KAYNAK SPREYİ

KOD	ÜRÜN	KOLİ	BİRİM	FİYAT
01.07.069	GK 2000 400ml	12	AD	22,03 ₺
01.07.070	GAZALTI KAYNAK PASTASI 250 ml	40	AD	29,68 ₺



### MUM SİLİKON

KOD	ÜRÜN	KOLİ	BİRİM	FİYAT
01.10.001	11.2 x 300 KALIN	20	KG	9,56 \$
01.10.002	7.5 x 300 İNCE	20	KG	10,58 \$



### DAYSON PU MASTİK 280 ml

KOD	ÜRÜN	KOLİ	BİRİM	FİYAT
01.04.001	BEYAZ	25	AD	3,80 €
01.04.002	SİYAH	25	AD	3,80 €
01.04.003	GRİ	25	AD	3,80 €



### LAVABO AÇICI

KOD	ÜRÜN	KOLİ	BİRİM	FİYAT
01.08.004	TOZ	12	AD	2,13 ₺
01.08.001	SIVI 500 gr	12	AD	7,00 ₺
01.08.002	SIVI 1000 gr	6	AD	12,75 ₺
01.08.003	SIVI 2000 gr	6	AD	23,25 ₺



**MUM SİLİKON TABANCASI**
**UGR**

KOD	ÜRÜN	KOLİ	BİRİM	FİYAT
	60 W	12	AD	10,55 \$
	80 W	12	AD	12,46 \$

**UGR 502 HIZLI YAPIŞTIRICI**
**UGR**

KOD	ÜRÜN	KOLİ	BİRİM	FİYAT
	20 gr	50	AD	1,52 \$

**FARE YAPIŞTIRICI**

KOD	ÜRÜN	PAKET	BİRİM	FİYAT
07.11.003	-	24	AD	8,06 ₺

**HERKÜL DAKSİL**
**UGR**

KOD	ÜRÜN	PAKET	BİRİM	FİYAT
04.23.020	METAL UÇLU	24	AD	0,97 \$

**HERKÜL KOLİ KALEMİ**
**UGR**

KOD	ÜRÜN	PAKET	BİRİM	FİYAT
-	KIRMIZI-MAVİ-SİYAH	12	AD	0,61 \$







# KRESMAN

PROFESSIONAL PRODUCTS





**BANT**





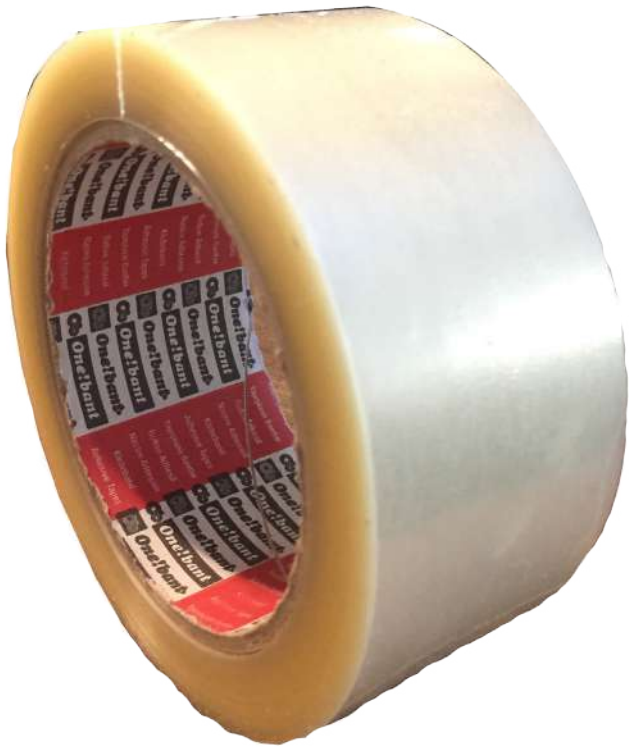

## HOTMELT **One!bant®**









Hotmelt koli bantları, sıcak eriyik tutkal teknolojisiyle üretilen bantlardır. 60° derece ısıya kadar dayanıklı olan bu bantları elinizle kolayca kopartabilirsiniz. Koli paketlenmesi için uygundur. Yüzeye uygulamak için fazla basınç uygulamaya gerekmez. Hava değişimlerine oldukça duyarlı olan bu ürün ısıya maruz kalmadıkları sürece 3-4 yıllık bir raf ömrüne sahiptir.

## AKRLİK **BanTape®**

Akrilik yapıştırıcıdan üretilen akrilik koli bantları, naylon ve plastik yüzeylerde kullanılmak üzere özel olarak geliştirilmiş bir koli bandı türüdür. Hızlı yapışma ve güçlü bir tutuculuk özelliğine sahip olan bu ürünleri elinizle kopartmanız oldukça zordur. Bu bantlar naylon ve plastik yüzeylerde etkin sonuçlar verdiği gibi, genel paketleme ve ambalajlama işlerimizde uygundur. Fiyatları hotmelt koli bantlarına göre biraz daha yüksektir. Baskılı koli bandı için uygun değildir.

## DOĞAL KAUÇUK **Unitape®**

Soğuk alan kullanımına uygun yüksek performans gösteren doğal kauçuk koli bandı. Koli ve kağıt türevi malzemelere üstün yapışma gücüne sahiptir.

ÜRÜN	KOLİ	BİRİM	One!bant®	BanTape®	Unitape®
ŞEFFAF 45x30 mt	72	AD	1,27 \$	0,55 \$	
ŞEFFAF 45x40 mt	72	AD	2,04 \$	0,70 \$	
ŞEFFAF 45x80 mt	96	AD	1,42 \$	0,86 \$	
ŞEFFAF 45x100 mt	96	AD	1,58 \$	1,08 \$	
KAHVE 45x30	72	AD	1,27 \$	0,55 \$	
KAHVE 45x40	72	AD	2,04 \$	0,70 \$	
KAHVE 45x80	96	AD	1,42 \$	0,86 \$	
KAHVE 45x100	96	AD	1,58 \$	1,08 \$	





## MASKELEME BANDI

Su ve solvent bazlı boya işleminde maskeleyen amaçlı kullanılır. Ahşap, metal, duvar, PVC ve cam gibi yüzeylerde kullanıma uygundur.

ÜRÜN	KOLİ	BİRİM	BanTape®	Unitape®
18 mm x 25 mt	96	AD	0,24 €	-
24 mm x 25 mt	72	AD	0,34 €	-
36 mm x 25 mt	48	AD	0,48 €	-
48 mm x 25 mt	36	AD	0,65 €	-
18MM X 30 MT	96	AD	-	0,50 €
24MM X 30 MT	72	AD	-	0,67 €
36MM X 30 MT	48	AD	-	1,00 €
48MM X 30 MT	36	AD	-	1,34 €



## ALÜMİNYUM FOLYO BANT

Yüksek basınçlı metal alaşımli havalandırma kanallarının izolasyonunda kullanımı uygundur. Yüksek nem geçirmezliğin gerekli olduğu yalıtım alanlarında kullanılır.



ÜRÜN	KOLİ	BİRİM	FİYAT
45 mm X 20 mt	72	AD	1,39 \$
72 mm X 20 mt	48	AD	2,23 \$
96 mm X 20 mt	24	AD	2,78 \$
45 mm X 10 mt	72	AD	0,74 \$

## VHB BANT

Perçin, vida ve kaynak gibi tüm birleştirme yöntemlerine alternatiftir. Aşınma, korozyon, kimyasal, nem gibi ağır şartlara dayanıklıdır. Her türlü malzemeyi birleştirir. Esneklik sağlar (Kalınlığının 3-5 katına kadar kopmadan esneyebilir) Hızlı ve kolay montaj sağlar. Tasarım özgürlüğü sağlar



ÜRÜN	KOLİ	BİRİM	FİYAT
18 mm X 2 mt	72	AD	0,92 \$
24 mm X 2 mt	48	AD	1,08 \$

## ÇİFT TARAFLI FİLMİK BANT

İşlevsel bir ürün olup ev, ofis, otomobil gibi tüm alanlarda kullanılmak üzere tasarlanan çift taraflı banttir.



ÜRÜN	KOLİ	BİRİM	FİYAT
48MM X 20MT	96	AD	1,58 \$
36MM X 20MT	72	AD	1,19 \$
24MM X 20MT	48	AD	0,79 \$
18MM X 20MT	36	AD	0,59 \$

## ÇİFT TARAFLI KÖPÜKLÜ BANT YEŞİL SİYAH



İşlevsel bir ürün olup ev, ofis, otomobil gibi tüm alanlarda kullanılmak üzere tasarlanan çift taraflı banttir.

ÜRÜN	KOLİ	BİRİM	FİYAT
15MM X 10MT	-	AD	0,78 \$
10MM X 10MT	-	AD	0,52 \$
18MM X 10MT	-	AD	1,05 \$
50MM X 10MT	-	AD	2,61 \$
40MM X 10MT	-	AD	2,09 \$
35MM X 10MT	-	AD	1,82 \$
30MM X 10MT	-	AD	1,50 \$
25MM X 10MT	-	AD	1,30 \$
20MM X 10MT	-	AD	1,05 \$



## DERZ BANTI

ÜRÜN	KOLİ	BİRİM	FİYAT
50MM X 20M	-	AD	0,80 \$
50MM X 45MT	-	AD	1,79 \$
100MM X 45MT	-	AD	3,60 \$
100MM X 90MT	-	AD	7,20 \$
50MM X 90MT	-	AD	3,60 \$

## TEFLON BANT

ÜRÜN	KOLİ	BİRİM	USGR
12 MM	-	AD	0,17 \$
DOĞALGAZ 12 MM	-	AD	0,50 \$



## ELEKTRİK BANTI

ÜRÜN	KOLİ	BİRİM	FİYAT
SİYAH-BEYA-RENKLİ	-	AD	0,19 \$



## MERDİVEN KAYDIRMAZ BANTI

ÜRÜN	KOLİ	BİRİM	FİYAT
18MM X 15MT	-	AD	4,28 \$
24MM X 15MT	-	AD	4,06 \$
48MM X 15MT	-	AD	2,03 \$
24MM X 5MT	-	AD	1,50 \$
BEYAZ 24MM X 5MT	-	AD	1,50 \$
24MM X 25MT	-	AD	6,77 \$
50MM X 25MT	-	AD	12,83 \$
50MM X 10MT	-	AD	5,42 \$
25MM X 10MT		AD	2,85 \$







## ÇİFT TARAFLI KÖPÜKLÜ BANT BEYAZ

ÜRÜN	KOLİ	BİRİM	FİYAT
18MM X 2MT	-	AD	0,25 \$
24MM X 2MT	-	AD	0,33 \$
36MM X 2MT	-	AD	0,48 \$
48MM X 2MT	-	AD	0,67 \$
18MM X 20MT	-	AD	1,58 \$
24MM X 20MT	-	AD	1,98 \$



## KAPI PENCERE BANTI

ÜRÜN	KOLİ	BİRİM	FİYAT
BEYAZ 100 MT	-	AD	24,00 \$
KAHVE 100 MT	-	AD	24,00 \$



## İKAZ ŞERİTİ

ÜRÜN	KOLİ	BİRİM	FİYAT
KÜÇÜK	-	AD	7,08 ₺
BÜYÜK	-	AD	13,80 ₺

## ÇOK AMAÇLI BANT (DUCK TAPE)

ÜRÜN	KOLİ	BİRİM	FİYAT
GRİ 45X10		AD	0,71 \$
SİYAH 45X10		AD	0,71 \$
KIRMIZI 45X10		AD	0,71 \$
SARI 45X10		AD	0,71 \$
MAVİ 45X10		AD	0,71 \$
YEŞİL 45X10		AD	0,71 \$
BEYAZ 45X10		AD	0,71 \$



## STREÇ

ÜRÜN	KOLİ	BİRİM	FİYAT
STREÇ 1100 GR	6	AD	5,75 \$
STREÇ 1200 GR	6	AD	2,76 \$
STREÇ 1300 GR	6	AD	3,00 \$
STREÇ 1900 GR	6	AD	3,26 \$
STREÇ 2300 GR	6	AD	5,28 \$
STREÇ 2000 GR	6	AD	6,36 \$
STREÇ 2100 GR	6	AD	5,52 \$
STREÇ 1700 GR	6	AD	5,83 \$
STREÇ 1800 GR	6	AD	4,80 \$
STREÇ 1150 GR	6	AD	5,04 \$
STREÇ 1500 GR	6	AD	2,88 \$
STREÇ 1000 GR	6	AD	3,77 \$
STREÇ 2050 GR	6	AD	3,41 \$





# Karbosan

shooprools  
mounted flap discs bench grinding

waterproof abrasive sheets cutting  
cup wheels

abrasive rolls grinding discs

bonded abrasive  
waterproof abrasive sheets

vitrified wheels  
thin cut-off discs

fiberglass  
diamond  
performance



230 x 3.0 x 2  
9" x 1/8" x







# KESİCİ DELİCİ AŞINDRICI





### SDS PLUS MATKAP UCU

KOD	ÜRÜN ADI	KOLİ	BİRİM	FİYAT
03.01.001	5X110	500	AD	0,84 \$
03.01.002	6X110	500	AD	0,85 \$
03.01.003	7X110	500	AD	0,86 \$
03.01.004	8X110	500	AD	0,88 \$
03.01.005	9X110	500	AD	0,93 \$
03.01.006	10X110	500	AD	0,97 \$
03.01.007	11X110	500	AD	1,07 \$
03.01.008	12X110	500	AD	1,22 \$
03.01.009	4X160	400	AD	0,83 \$
03.01.010	5X160	400	AD	0,86 \$
03.01.011	6X160	400	AD	0,86 \$
03.01.012	7X160	400	AD	0,96 \$
03.01.013	8X160	400	AD	1,00 \$
03.01.014	9X160	400	AD	1,05 \$
03.01.015	10X160	300	AD	1,08 \$
03.01.016	11X160	300	AD	1,16 \$
03.01.017	12X160	250	AD	1,18 \$
03.01.018	13X160	250	AD	1,52 \$
03.01.019	14X160	250	AD	1,75 \$
03.01.020	15X160	150	AD	1,92 \$
03.01.021	16X160	150	AD	2,00 \$
03.01.022	17X160	150	AD	2,11 \$
03.01.023	18X160	150	AD	2,24 \$
03.01.024	20X160	150	AD	2,27 \$
03.01.025	5X210	250	AD	1,08 \$
03.01.026	5,5X210	250	AD	1,11 \$
03.01.027	6X210	250	AD	1,08 \$
03.01.028	6,5X210	250	AD	1,13 \$
03.01.029	7X210	250	AD	1,22 \$
03.01.030	8X210	250	AD	1,23 \$
03.01.031	9X210	250	AD	1,25 \$
03.01.032	10X210	250	AD	1,30 \$
03.01.033	11X210	250	AD	1,37 \$
03.01.034	12X210	250	AD	1,52 \$
03.01.035	13X210	250	AD	1,74 \$
03.01.036	14X210	250	AD	2,16 \$
03.01.037	15X210	200	AD	2,46 \$
03.01.038	16X210	200	AD	2,63 \$
03.01.039	17X210	200	AD	2,85 \$
03.01.040	18X210	200	AD	3,20 \$
03.01.041	19X210	200	AD	3,53 \$



### SDS PLUS MATKAP UCU

KOD	ÜRÜN ADI	KOLİ	BİRİM	FİYAT
03.01.042	6X260	200	AD	1,50 \$
03.01.043	8X260	200	AD	1,53 \$
03.01.044	10X260	200	AD	1,61 \$
03.01.045	12X260	200	AD	1,64 \$
03.01.046	14X260	200	AD	2,42 \$
03.01.047	16X260	200	AD	3,21 \$
03.01.048	8X300	100	AD	1,79 \$
03.01.049	10X300	100	AD	1,94 \$
03.01.050	12X300	100	AD	2,12 \$
03.01.051	14X300	100	AD	2,74 \$
03.01.052	16X300	100	AD	3,67 \$
03.01.053	18X300	100	AD	4,42 \$
03.01.054	8X350	50	AD	2,01 \$
03.01.055	10X350	50	AD	2,04 \$
03.01.056	12X350	50	AD	2,15 \$
03.01.057	14X350	50	AD	3,02 \$
03.01.058	16X350	50	AD	3,91 \$
03.01.059	18X350	50	AD	4,36 \$
03.01.060	20X350	50	AD	5,01 \$
03.01.061	22X350	50	AD	6,65 \$
03.01.062	24X350	50	AD	7,67 \$
03.01.063	26X350	50	AD	8,07 \$
03.01.064	10X450	50	AD	2,69 \$
03.01.065	12X450	50	AD	2,85 \$
03.01.066	14X450	50	AD	3,61 \$
03.01.067	16X450	50	AD	4,17 \$
03.01.068	18X450	50	AD	5,54 \$
03.01.069	20X450	50	AD	6,70 \$
03.01.070	22X450	50	AD	7,63 \$
03.01.071	24X450	50	AD	9,30 \$
03.01.072	25X450	50	AD	9,99 \$
03.01.073	26X450	50	AD	10,67 \$
03.01.074	28X450	50	AD	10,94 \$
03.01.075	20X210	50	AD	3,83 \$



### SDS PLUS MURÇ KESKİ 14X250

KOD	ÜRÜN ADI	KOLİ	BİRİM	FİYAT
03.01.094	MURÇ	100	AD	1,78 \$
03.01.095	KESKİ	100	AD	1,78 \$
03.01.096	GENİŞ KESKİ	100	AD	4,21 \$

### SDS MAX MATKAP UCU

KOD	ÜRÜN ADI	KOLİ	BİRİM	FİYAT
03.02.001	12X340	50	AD	9,55 \$
03.02.002	14X340	50	AD	10,26 \$
03.02.003	16X340	50	AD	11,29 \$
03.02.004	16X540	25	AD	15,73 \$
03.02.005	18X340	50	AD	12,11 \$
03.02.006	18X520	25	AD	16,83 \$
03.02.007	20X340	50	AD	13,34 \$
03.02.008	20X520	25	AD	19,43 \$
03.02.009	22X340	50	AD	15,05 \$
03.02.010	22X520	25	AD	20,93 \$
03.02.011	24X340	50	AD	17,37 \$
03.02.012	24X520	25	AD	23,26 \$
03.02.013	25X340	50	AD	19,43 \$
03.02.014	25X520	25	AD	25,31 \$
03.02.015	26X340	50	AD	19,43 \$
03.02.016	26X520	25	AD	25,31 \$
03.02.017	28X340	50	AD	24,21 \$
03.02.018	28X520	25	AD	29,69 \$
03.02.019	30X570	50	AD	35,57 \$
03.02.020	32X570	25	AD	28,78 \$
03.02.021	16X520	50	AD	15,73 \$
03.02.022	28X570	25	AD	29,82 \$
03.02.023	35X570	15	AD	49,25 \$
03.02.024	20X540	15	AD	19,43 \$



### SDS MAX MURÇ - KESKİ

KOD	ÜRÜN ADI	KOLİ	BİRİM	FİYAT
03.02.037	KESKİ 400	50	AD	4,65 \$
03.02.038	KESKİ 500	25	AD	5,38 \$
03.02.039	KESKİ 600	25	AD	6,84 \$
03.02.040	MURÇ 400	50	AD	4,65 \$
03.02.041	MURÇ 500	25	AD	5,38 \$
03.02.042	MURÇ 600	25	AD	6,84 \$
03.02.043	GENİŞ KESKİ 400	25	AD	5,47 \$

### SDS PLUS AHŞAP MATKAP UCU

KOD	ÜRÜN ADI	KOLİ	BİRİM	FİYAT
03.01.097	8X300	-	AD	2,14 \$
03.01.098	10X300	-	AD	2,32 \$
03.01.099	12X300	-	AD	2,88 \$
03.01.100	14X300	-	AD	3,06 \$
03.01.101	16X300	-	AD	3,53 \$
03.01.102	18X300	-	AD	4,15 \$
03.01.103	20X300	-	AD	5,03 \$
03.01.104	22X300	-	AD	5,88 \$
03.01.106	10X500	-	AD	3,90 \$
03.01.107	12X500	-	AD	4,90 \$
03.01.108	14X500	-	AD	5,17 \$
03.01.109	16X500	-	AD	5,72 \$
03.01.110	18X500	-	AD	6,32 \$
03.01.111	20X500	-	AD	8,25 \$
03.01.112	22X500	-	AD	9,43 \$
03.01.113	24X500	-	AD	10,85 \$



### KORUMALI MURÇ - KESKİ

KOD	ÜRÜN ADI	KOLİ	BİRİM	FİYAT
03.18.017	MURÇ	12	AD	23,26 ₺
03.18.001	KESKİ	12	AD	23,26 ₺



### MURÇ - KESKİ

KOD	ÜRÜN ADI	KOLİ	BİRİM	FİYAT
03.18.015	MURÇ	12	AD	1,33 \$
03.18.002	KESKİ	12	AD	1,33 \$

### HSS MATKAP UCU

KOD	ÜRÜN ADI	KOLİ	BİRİM	FİYAT
03.03.002	1,0 MM	10/100	AD	0,11 \$
03.03.003	1,5 MM	10/100	AD	0,11 \$
03.03.004	2,0 MM	10/100	AD	0,13 \$
03.03.005	2,5 MM	10/100	AD	0,14 \$
03.03.006	3,0 MM	10/100	AD	0,14 \$
03.03.007	3,5 MM	10/100	AD	0,15 \$
03.03.008	4,0 MM	10/100	AD	0,18 \$
03.03.009	4,2 MM	10/100	AD	0,19 \$
03.03.010	4,5 MM	10/100	AD	0,20 \$
03.03.011	5,0 MM	10/100	AD	0,22 \$
03.03.012	5,5 MM	10/100	AD	0,27 \$
03.03.013	6,0 MM	10/100	AD	0,30 \$
03.03.014	6,5 MM	10/100	AD	0,37 \$
03.03.015	7,0 MM	5/50	AD	0,45 \$
03.03.016	7,5 MM	5/50	AD	0,53 \$
03.03.017	8,0 MM	5/50	AD	0,62 \$
03.03.018	8,5 MM	5/50	AD	0,68 \$
03.03.019	9,0 MM	5/50	AD	0,79 \$
03.03.020	9,5 MM	5/50	AD	0,84 \$
03.03.021	10,0 MM	5/50	AD	0,92 \$
03.03.022	10,5 MM	5/50	AD	1,05 \$
03.03.023	11,0 MM	5/50	AD	1,16 \$
03.03.024	11,5 MM	5/50	AD	1,29 \$
03.03.025	12,0 MM	5/50	AD	1,41 \$
03.03.026	12,5 MM	5/50	AD	1,57 \$
03.03.027	13,0 MM	5/50	AD	1,79 \$
03.03.028	13,5 MM	5/50	AD	2,22 \$
03.03.029	14,0 MM	5/50	AD	2,44 \$
03.03.030	14,5 MM	5/50	AD	2,49 \$
03.03.031	15,0 MM	5/50	AD	3,21 \$
03.03.032	15,5 MM	5/50	AD	3,28 \$
03.03.033	16,0 MM	5/50	AD	3,61 \$
03.03.034	16,5 MM	5/50	AD	3,63 \$
03.03.035	17,0 MM	5/50	AD	3,87 \$
03.03.036	17,5 MM	5/50	AD	4,10 \$
03.03.037	18,0 MM	5/50	AD	4,38 \$
03.03.038	18,5 MM	5/50	AD	4,68 \$
03.03.039	19,0 MM	5/50	AD	4,84 \$
03.03.040	20,0 MM	5/50	AD	5,47 \$

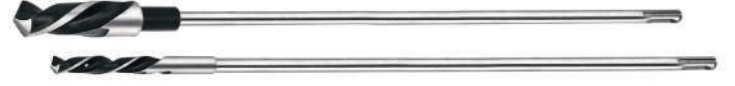

### SDS PLUS KALIPÇI MATKAP UCU

KOD	ÜRÜN ADI	KOLİ	BİRİM	FİYAT
03.01.114	10X600	-	AD	5,08 \$
03.01.115	12X600	-	AD	6,35 \$
03.01.116	14X600	-	AD	7,20 \$
03.01.117	16X600	-	AD	8,04 \$
03.01.118	18X600	-	AD	10,58 \$
03.01.119	20X600	-	AD	12,27 \$
03.01.120	22X600	-	AD	13,12 \$



### ELMAS BETON MATKAP UCU

KOD	ÜRÜN ADI	KOLİ	BİRİM	FİYAT
03.04.001	4X75	50/1000	AD	0,30 \$
03.04.002	5X85	50/1000	AD	0,39 \$
03.04.003	6X100	50/750	AD	0,51 \$
03.04.004	7X100	50/600	AD	0,72 \$
03.04.005	8X120	50/600	AD	0,81 \$
03.04.006	9X120	50/400	AD	0,99 \$
03.04.007	10X120	50/300	AD	1,04 \$
03.04.008	12X150	50/300	AD	1,88 \$



### BİTS UÇ TORX

KOD	ÜRÜN ADI	PAKET	BİRİM	FİYAT
03.05.029	T30x50	20	AD	0,25 \$
03.05.030	T30x75	20	AD	0,41 \$
03.05.031	T30x90	20	AD	0,51 \$



### MANYETİK BİTS ADAPTÖRÜ

KOD	ÜRÜN ADI	PAKET	BİRİM	FİYAT
03.05.032	10x60	10	AD	1,68 \$



### BİTS UÇ YILDIZ (Matkap Uçlu vidalar İçin)

KOD	ÜRÜN ADI	PAKET	BİRİM	FİYAT
03.05.001	PH1 X 25	40	AD	0,13 \$
03.05.002	PH1 X 50	20	AD	0,25 \$
03.05.003	PH1 X 75	20	AD	0,36 \$
03.05.004	PH1 X 90	20	AD	0,47 \$
03.05.005	PH2 X 25	40	AD	0,13 \$
03.05.006	PH2 X 50	20	AD	0,25 \$
03.05.007	PH2 X 75	20	AD	0,36 \$
03.05.008	PH2 X 90	20	AD	0,47 \$
03.05.009	PH2 X 100	10	AD	0,47 \$
03.05.010	PH2 X 150	10	AD	0,71 \$
03.05.011	PH3 X 25	40	AD	0,13 \$
03.05.012	PH3 X 50	20	AD	0,25 \$
03.05.013	PH3 X 75	20	AD	0,36 \$
03.05.014	PH3 X 90	20	AD	0,47 \$



### MANYETİK SOMUN ADAPTÖRÜ

KOD	ÜRÜN ADI	PAKET	BİRİM	FİYAT
03.06.001	6X45	10	AD	0,36 \$
03.06.002	7X45	10	AD	0,36 \$
03.06.003	8X45	10	AD	0,36 \$
03.06.004	8X65	10	AD	2,84 \$
03.06.005	10X45	10	AD	0,44 \$
03.06.006	10X65	10	AD	0,48 \$
03.06.007	9X45	10	AD	0,41 \$
03.06.008	11X45	8	AD	0,56 \$
03.06.009	12X45	6	AD	0,56 \$
03.06.010	13X45	6	AD	0,59 \$
03.06.011	14X45	5	AD	0,75 \$
03.06.012	15X45	5	AD	1,34 \$
03.06.013	17X45	5	AD	1,44 \$
03.06.014	17X65	5	AD	5,47 \$
03.06.015	14X65	5	AD	3,76 \$
03.06.016	15X65	5	AD	4,13 \$



### BİTS UÇ POZİ (Sunta Vidaları İçin)

KOD	ÜRÜN ADI	PAKET	BİRİM	FİYAT
03.05.015	PZ1 X 25	40	AD	0,13 \$
03.05.016	PZ1 X 50	20	AD	0,25 \$
03.05.017	PZ1 X 75	20	AD	0,36 \$
03.05.018	PZ1 X 90	20	AD	0,47 \$
03.05.019	PZ2 X 25	40	AD	0,13 \$
03.05.020	PZ2 X 50	20	AD	0,25 \$
03.05.021	PZ2 X 75	20	AD	0,36 \$
03.05.022	PZ2 X 90	20	AD	0,47 \$
03.05.023	PZ2 X 100	10	AD	0,47 \$
03.05.024	PZ2 X 150	10	AD	0,71 \$
03.05.025	PZ3 X 25	40	AD	0,14 \$
03.05.026	PZ3 X 50	20	AD	0,27 \$
03.05.027	PZ3 X 75	20	AD	0,39 \$
03.05.028	PZ3 X 90	20	AD	0,51 \$



### SDS PLUS UÇ ADAPTÖRÜ

KOD	ÜRÜN ADI	PAKET	BİRİM	FİYAT
03.01.121	-	50	AD	1,69 \$



### SDS PLUS MANDREN ADAPTÖRÜ

KOD	ÜRÜN ADI	PAKET	BİRİM	FİYAT
03.01.122	-		AD	2,32 \$



### ŞAPKALI BİTS UÇ

KOD	ÜRÜN ADI	PAKET	BİRİM	FİYAT
03.05.063	PH2x25	12	AD	0,72 \$





### TURBO ELMAS KESİCİ

KOD	ÜRÜN ADI	PAKET	BİRİM	FİYAT
03.08.002	115X1,9	50	AD	3,39 \$
03.08.003	180X2,2	50	AD	7,35 \$
03.08.004	230X2,4	50	AD	16,38 \$
03.18.058	115x1.2 HASSAS	25	AD	9,06 \$



### CAM KAZIMA BIÇAĞI

KOD	ÜRÜN ADI	PAKET	BİRİM	FİYAT
03.10.007	PLASTİK	24	AD	0,60 \$



### DEMİR TESTERE AĞIZI

KOD	ÜRÜN ADI	PAKET	BİRİM	FİYAT
03.12.002	GENİŞ	72	AD	0,33 \$
03.12.001	DAR	144	AD	0,23 \$



### KENİTO DEKUPAJ TESTERE BIÇAĞI

KOD	ÜRÜN ADI	PAKET	BİRİM	FİYAT
03.11.001	T118 A (92MM)	50	AD	0,52 \$
03.01.002	T318 A (132MM)	50	AD	0,32 \$

### MAKET BIÇAĞI

KOD	ÜRÜN ADI	PAKET	BİRİM	FİYAT
03.10.001	PLASTİK	40	AD	0,26 \$
03.10.002	DEMİR UÇLU	40	AD	0,69 \$
03.10.003	METAL	40	AD	0,96 \$



### MAKET BIÇAĞI YEDEK AĞZI

KOD	ÜRÜN ADI	PAKET	BİRİM	FİYAT
03.10.004	GENİŞ	100	AD	4,44 \$
03.10.005	DAR	100	AD	4,08 \$



### KOLASTAR KOLU

KOD	ÜRÜN ADI	KOLİ	BİRİM	FİYAT
03.17.001	63 MM	12	AD	25,31 ₺
03.17.002	76 MM	12	AD	25,99 ₺



### KOLASTAR AĞZI

KOD	ÜRÜN ADI	KOLİ	BİRİM	FİYAT
03.17.003	63 MM	12	AD	14,35 ₺
03.17.004	76 MM	12	AD	14,91 ₺





**EBRAR**  
HIRDAVAT



**BOSCH**

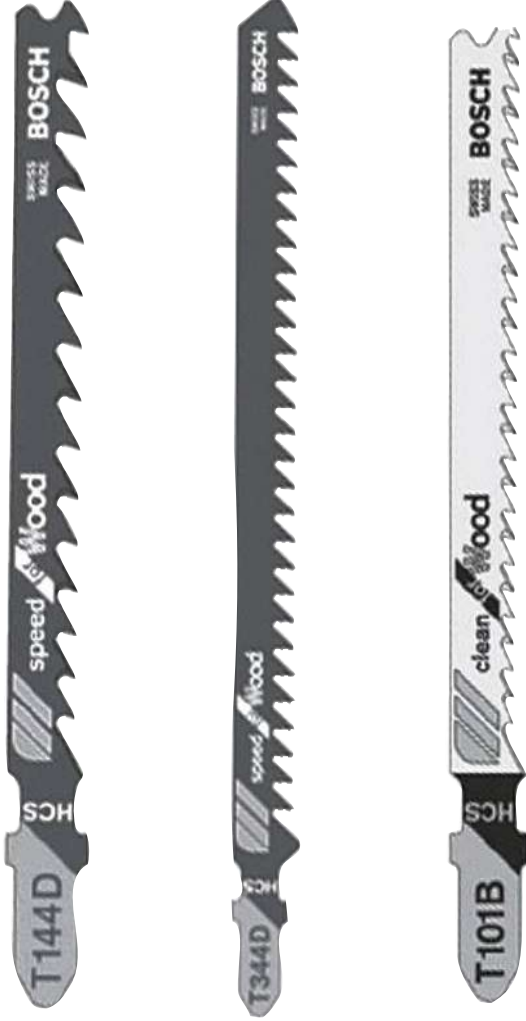

#### Dekupaj Testere Bıçakları (AHSAP HIZLI KESİM)

KOD	ÜRÜN ADI	PAKET	BİRİM	FİYAT
2608637880	T144D 100 mm	100	AD	0,59 €
2608633A34	T344D 152 mm	100	AD	1.01 €
	T111C 100 mm	100	AD	0,73 €
	T308B 117 mm	100	AD	1,44 €

#### Dekupaj Testere Bıçakları (AHSAP TEMİZ KESİM)

KOD	ÜRÜN ADI	PAKET	BİRİM	FİYAT
2608637876	T101B 100 mm	100	AD	1,32 €



#### Dekupaj Testere Bıçakları (METAL KESİM)

KOD	ÜRÜN ADI	PAKET	BİRİM	FİYAT
2608631964	T118A 92 mm	100	AD	0,89 €
2608631808	T318A 132 mm	100	AD	1,55 €
2608631404	T318B 132 mm	5	AD	1,98 €

#### Dekupaj Testere Bıçakları (METAL HIZLI KESİM)

KOD	ÜRÜN ADI	KOLİ	BİRİM	FİYAT
2608636695	T121GF 3'lü	1	PK	7,06 €
2608636697	T121GF 25'li	1	PK	74,57 €

## BOSCH BİTS UÇ

KOD	ÜRÜN ADI	PAKET	BİRİM	FİYAT
2607001513	PH2*25 mm 25'li	1	AD	23,06 €
2607002503	PH2*49 mm 25'li	1	AD	32,78 €
2607001577	PZ2*49 mm 3'lü	1	AD	4,95 €
2607002506	PZ2*49 mm 25'li	1	AD	33,55 €



## BOSCH BİTS UÇ SET

KOD	ÜRÜN ADI	PAKET	BİRİM	FİYAT
2607017164	43 Parça	1	AD	42,10 €
2607017319	32 Parça	1	AD	21,06 €



## BOSCH SUNTA KESME TESTERESİ

KOD	ÜRÜN ADI	PAKET	BİRİM	FİYAT
2608640817	185X24 DİŞ	1	AD	22,73 €
2608641181	185X48 DİŞ	1	AD	30,62 €
2608640612	190X24 DİŞ	1	AD	24,66 €
2608640614	190X48 DİŞ	1	AD	31,18 €





**İŞIKLAR EL TESTERESİ**

KOD	ÜRÜN ADI	PAKET	BİRİM	FİYAT
04.24.005	12 ASLAN	12	AD	23,87 ₺
04.24.008	14 ASLAN	12	AD	25,46 ₺
	12 TİMSAH	12	AD	27,23 ₺
	14 TİMSAH	12	AD	28,76 ₺
	10 TİMSAH DİK DİŞ	12	AD	33,54 ₺
	12 TİMSAH DİK DİŞ	12	AD	34,27 ₺
	14 TİMSAH DİK DİŞ	12	AD	35,37 ₺

**İŞIKLAR PALA TESTERE**

KOD	ÜRÜN ADI	PAKET	BİRİM	FİYAT
	50 cm FİL	12	AD	44,68 ₺
	55 cm FİL	12	AD	48,65 ₺
	45 cm SARI	12	AD	59,12 ₺
	50 cm SARI	12	AD	60,28 ₺
	55 cm SARI	12	AD	61,63 ₺
	45 cm MAVİ	12	AD	59,12 ₺
	50 cm MAVİ	12	AD	60,28 ₺
	55 cm MAVİ	12	AD	61,63 ₺
	45 cm ASLAN	12	AD	44,68 ₺
	50 cm ASLAN	12	AD	46,39 ₺
	55 cm ASLAN	12	AD	47,49 ₺

**İŞIKLAR BAĞ TESTERESİ**

KOD	ÜRÜN ADI	PAKET	BİRİM	FİYAT
	NO:5	12	AD	22,64 ₺
	NO:6 DİK DİŞLİ	12	AD	32,99 ₺
	NO:6 KILIFLI	12	AD	38,31 ₺
	BUDAMA	12	AD	32,62 ₺
	BUDAMA KILIFLI	12	AD	37,94 ₺

**İŞIKLAR BAĞ ZEYTİN TESTERESİ**

KOD	ÜRÜN ADI	PAKET	BİRİM	FİYAT
	NO:10	12	AD	35,99 ₺
	NO:10 KILIFLI	12	AD	40,39 ₺
	KATLANIR	12	AD	39,29 ₺



**İŞIKLAR OYGU TESTERESİ**

KOD	ÜRÜN ADI	PAKET	BİRİM	FİYAT
	NO:5	12	AD	34,27 ₺



**İŞIKLAR KARTONPİYER TESTERESİ**

KOD	ÜRÜN ADI	PAKET	BİRİM	FİYAT
04.24.015	ALÇIPAN	12	AD	29,74 ₺
	ALÇIPAN KATLANIR	12	AD	40,27 ₺



**İŞIKLAR GAZBETON TESTERESİ**

KOD	ÜRÜN ADI	PAKET	BİRİM	FİYAT
04.24.011	50 cm / NORMAL	6	AD	40,39 ₺
04.24.012	55 cm / NORMAL	6	AD	41,62 ₺
04.24.003	50 cm / ELMAS	6	AD	105,88 ₺
	55 cm / ELMAS	6	AD	116,59 ₺



**İŞIKLAR PLASTİK TESTERESİ**

KOD	ÜRÜN ADI	PAKET	BİRİM	FİYAT
	50 cm PLASTİK SAPLI	12	AD	113,83 ₺
	55 cm PLASTİK SAPLI	12	AD	119,95 ₺



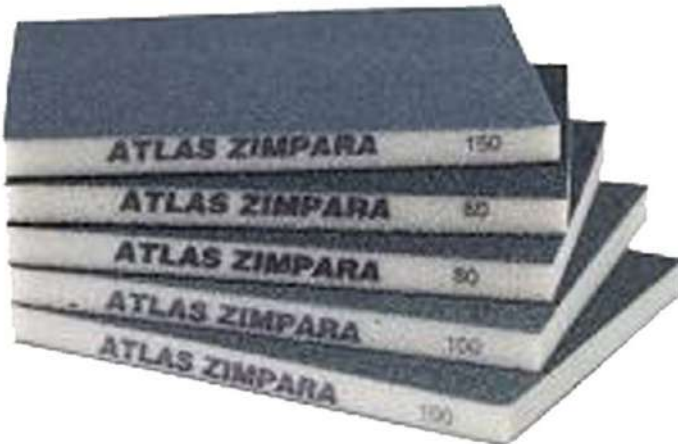

### IŞIKLAR STRAFOR TESTERESİ

KOD	ÜRÜN ADI	PAKET	BİRİM	FİYAT
	NO:12 EL TİPİ	12	AD	40,27 ₺
	NO:14 EL TİPİ	12	AD	32,56 ₺
	NO:5 BAĞ TİPİ			34,09 ₺
	NO:6 BAĞ TİPİ			28,46 ₺

### IŞIKLAR KOLASTAR AĞIZI

KOD	ÜRÜN ADI	PAKET	BİRİM	FİYAT
	61 cm ÇATAL	12	AD	14,08 ₺
	76 cm ÇATAL	12	AD	14,63 ₺
	61 cm ÇATAL	12	AD	14,20 ₺
	76 cm ÇATAL	12	AD	14,63 ₺

### VELCRO CİRTLİ ZIMPARA MERMER



KOD	ÜRÜN ADI	KOLİ	BİRİM	FİYAT
	115x40	100/1000	AD	0,16 \$
	115x60	100/1000	AD	0,16 \$
	115x80	100/1000	AD	0,16 \$
	115x100	100/1000	AD	0,16 \$
	115x120	100/1000	AD	0,16 \$
	115x150	100/1000	AD	0,16 \$
	115x180	100/1000	AD	0,16 \$
	115x220	100/1000	AD	0,16 \$
	115x320	100/1000	AD	0,16 \$
	115x400	100/1000	AD	0,16 \$
	115x600	100/1000	AD	0,16 \$
	115x800	100/1000	AD	0,16 \$
	115x1000	100/1000	AD	0,16 \$
	115x1200	100/1000	AD	0,16 \$

### ATLAS SÜNGER ZIMPARA 98X123X10

KOD	ÜRÜN ADI	KOLİ	BİRİM	FİYAT
A-03.18.050	46 KUM	-	AD	4,16 ₺
A-03.18.051	60 KUM	-	AD	4,16 ₺
A-03.18.052	80 KUM	-	AD	4,16 ₺
A-03.18.053	100 KUM	-	AD	4,16 ₺
A-03.18.054	120 KUM	-	AD	4,16 ₺
A-03.18.055	150 KUM	-	AD	4,16 ₺
A-03.18.056	180 KUM	-	AD	4,16 ₺
A-03.18.057	220 KUM	-	AD	4,16 ₺



### ATLAS RULO ZIMPARA 200x50

KOD	ÜRÜN ADI	KOLİ	BİRİM	FİYAT
A-03.19.009	36 KUM	-	AD	36,34 ₺
A-03.19.015	40 KUM	-	AD	33,41 ₺
A-03.19.014	60 KUM	-	AD	30,37 ₺
A-03.19.013	80 KUM	-	AD	27,34 ₺
A-03.19.010	100 KUM	-	AD	27,34 ₺
A-03.19.011	120 KUM	-	AD	27,34 ₺
A-03.19.012	150 KUM	-	AD	27,34 ₺



### ATLAS SU ZIMPARASI

KOD	ÜRÜN ADI	KOLİ	BİRİM	FİYAT
A-03.18.006	60 KUM	50/250	AD	4,34 ₺
A-03.18.007	80 KUM	50/250	AD	4,16 ₺
A-03.18.014	100 KUM	50/250	AD	3,98 ₺
A-03.18.013	120 KUM	50/250	AD	3,89 ₺
A-03.18.010	150 KUM	50/500	AD	3,34 ₺
A-03.18.011	180 KUM	50/500	AD	3,16 ₺
A-03.18.009	220 KUM	50/500	AD	3,07 ₺
A-03.18.022	240 KUM	50/500	AD	3,07 ₺
A-03.18.008	280 KUM	50/500	AD	3,07 ₺
A-03.18.062	320 KUM	50/500	AD	3,07 ₺
A-03.18.058	360 KUM	50/500	AD	3,07 ₺
A-03.18.003	400 KUM	50/500	AD	3,07 ₺
A-03.18.004	500 KUM	50/500	AD	3,07 ₺
A-03.18.016	600 KUM	50/500	AD	3,07 ₺
A-03.18.005	800 KUM	50/500	AD	3,44 ₺
A-03.18.020	1200 KUM	50/500	AD	3,44 ₺
A-03.18.021	1000 KUM	50/500	AD	3,44 ₺



### ATLAS SÜNGER ZIMPARA 92X68X25

KOD	ÜRÜN ADI	KOLİ	BİRİM	FİYAT
A-03.18.050	46 KUM	-	AD	4,16 ₺
A-03.18.051	60 KUM	-	AD	4,16 ₺
A-03.18.052	80 KUM	-	AD	4,16 ₺
A-03.18.053	100 KUM	-	AD	4,16 ₺
A-03.18.054	120 KUM	-	AD	4,16 ₺
A-03.18.055	150 KUM	-	AD	4,16 ₺
A-03.18.056	180 KUM	-	AD	4,16 ₺
A-03.18.057	220 KUM	-	AD	4,16 ₺





**Bİ-METAL PAŇ** 

KOD	ÜRÜN ADI	KOLİ	BİRİM	FİYAT
03.07.001	14 MM	50/200	AD	2,57 \$
03.07.002	16 MM	50/200	AD	2,93 \$
03.07.003	17 MM	50/200	AD	3,12 \$
03.07.004	19 MM	50/200	AD	3,52 \$
03.07.005	20 MM	50/200	AD	3,67 \$
03.07.006	21 MM	50/200	AD	3,85 \$
03.07.007	22 MM	50/200	AD	4,04 \$
03.07.008	24 MM	50/200	AD	4,40 \$
03.07.009	25 MM	50/200	AD	4,62 \$
03.07.010	26 MM	50/200	AD	5,21 \$
03.07.011	27 MM	50/200	AD	5,31 \$
03.07.012	30 MM	50/200	AD	5,50 \$
03.07.013	32 MM	50/200	AD	5,87 \$
03.07.014	35 MM	50/100	AD	6,42 \$
03.07.015	38 MM	50/100	AD	6,97 \$
03.07.016	40 MM	50/100	AD	7,33 \$
03.07.017	41 MM	50/100	AD	7,51 \$
03.07.018	44 MM	50/100	AD	8,07 \$
03.07.068	45 MM	50/100	AD	8,07 \$
03.07.019	46 MM	50/100	AD	8,44 \$
03.07.020	48 MM	50/100	AD	8,80 \$
03.07.070	50 MM	50/100	AD	9,35 \$
03.07.021	51 MM	50/100	AD	9,35 \$
03.07.022	52 MM	25/50	AD	9,53 \$
03.07.023	54 MM	25/50	AD	9,90 \$
03.07.024	55 MM	25/50	AD	10,08 \$
03.07.025	57 MM	25/50	AD	10,45 \$
03.07.026	60 MM	25/50	AD	11,00 \$
03.07.069	62 MM	25/50	AD	11,56 \$
03.07.027	63 MM	25/50	AD	11,56 \$
03.07.028	64 MM	25/50	AD	11,73 \$
03.07.029	65 MM	25/50	AD	11,91 \$
03.07.030	67 MM	25/50	AD	12,28 \$
03.07.056	68 MM	25/50	AD	12,28 \$
03.07.031	70 MM	25/50	AD	12,84 \$
03.07.032	73 MM	25/50	AD	13,38 \$
03.07.033	76 MM	25/50	AD	13,93 \$
03.07.034	79 MM	10/50	AD	14,49 \$
03.07.035	83 MM	10/50	AD	15,23 \$
03.07.036	86 MM	10/50	AD	15,78 \$
03.07.037	89 MM	10/50	AD	16,31 \$

**Bİ-METAL PAŇ** 

KOD	ÜRÜN ADI	KOLİ	BİRİM	FİYAT
03.07.038	92 MM	10/50	AD	16,86 \$
03.07.039	95 MM	10/50	AD	17,42 \$
03.07.040	98 MM	10/50	AD	17,97 \$
03.07.041	102 MM	10/20	AD	18,70 \$
03.07.042	105 MM	20	AD	19,24 \$
03.07.043	108 MM	20	AD	19,80 \$
03.07.057	90 MM	20	AD	20,30 \$
03.07.058	110 MM	20	AD	29,89 \$
03.07.044	111 MM	20	AD	20,35 \$
03.07.045	114 MM	20	AD	20,90 \$
03.07.046	121 MM	20	AD	22,22 \$
03.07.047	127 MM	10	AD	23,28 \$
03.07.048	130 MM	10	AD	23,83 \$
03.07.049	140 MM	10	AD	25,66 \$
03.07.050	152 MM	10	AD	27,86 \$
03.07.051	160 MM	10	AD	29,33 \$
03.07.059	165 MM	10	AD	30,79 \$
03.07.052	168 MM	10	AD	30,79 \$
03.07.053	178 MM	10	AD	32,63 \$
03.07.054	200 MM	10	AD	36,66 \$
03.07.055	210 MM	10	AD	38,50 \$

**PANÇ ADAPTÖRÜ HEX** 

KOD	ÜRÜN ADI	KOLİ	BİRİM	FİYAT
03.07.064	14-32	50	AD	3,31 \$
03.07.065	32-210	50	AD	7,57 \$

**PANÇ ADAPTÖRÜ SDS** 

KOD	ÜRÜN ADI	KOLİ	BİRİM	FİYAT
03.07.066	14-32	50	AD	4,77 \$
03.07.067	32-210	50	AD	8,02 \$



### BETON PANÇ



KOD	ÜRÜN ADI	KOLİ	BİRİM	FİYAT
03.72.079	30 MM	50	AD	4,91 \$
03.72.080	35 MM	50	AD	5,40 \$
03.72.081	40 MM	50	AD	6,35 \$
03.72.082	45 MM	50	AD	6,84 \$
03.72.073	50 MM	25	AD	7,34 \$
03.72.083	55 MM	25	AD	8,32 \$
03.72.084	60 MM	25	AD	8,81 \$
03.72.085	65 MM	25	AD	9,30 \$
03.72.086	70 MM	25	AD	10,78 \$
03.72.087	75 MM	25	AD	10,96 \$
03.72.088	80 MM	25	AD	12,29 \$
03.07.080	85 MM	25	AD	13,75 \$
03.07.081	90 MM	10	AD	23,27 \$
03.07.082	95 MM	10	AD	12,26 \$
03.72.092	100 MM	10	AD	20,80 \$
03.07.083	105 MM	10	AD	27,50 \$
03.72.074	110 MM	10	AD	24,58 \$
03.07.084	115 MM	10	AD	30,46 \$
03.72.075	120 MM	10	AD	27,22 \$

### 7'Lİ PANÇ SETİ



KOD	ÜRÜN ADI	KOLİ	BİRİM	FİYAT
03.07.060	25 - 62	10/60	AD	4,06 \$



### AHŞAP VE ALÇIPAN PANÇ SETİ



KOD	ÜRÜN ADI	KOLİ	BİRİM	FİYAT
03.07.061	8'Lİ	-	AD	7,56
03.07.062	11'Lİ	-	AD	9,91
03.07.063	16'Lİ	-	AD	12,31

### MERMER GRANİT PANÇ



KOD	ÜRÜN ADI	KOLİ	BİRİM	FİYAT
03.07.088	18 MM	50/100	AD	15,66 \$
03.07.091	20 MM	50/100	AD	16,74 \$
03.07.094	22 MM	50/100	AD	18,00 \$
03.07.095	25 MM	50/100	AD	19,80 \$
03.07.096	28 MM	50/100	AD	21,60 \$
03.07.087	33 MM	50/100	AD	25,92 \$
03.07.097	35 MM	50/100	AD	27,00 \$
03.07.098	38 MM	25/50	AD	29,88 \$
03.07.099	45 MM	25/50	AD	34,02 \$
03.07.100	52 MM	25/50	AD	34,74 \$
03.07.101	57 MM	25/50	AD	35,10 \$
03.07.102	63 MM	25/50	AD	50,04 \$



### HAND EĞELER



KOD	ÜRÜN ADI	KOLİ	BİRİM	FİYAT
03.13.015	ORTA 6"	-	AD	1,78 \$
03.13.016	ORTA 8"	-	AD	2,40 \$
03.13.017	ORTA 10"	-	AD	3,10 \$
03.13.018	ORTA 12"	-	AD	4,77 \$
03.13.019	KALIN 6"	-	AD	1,67 \$
03.13.020	KALIN 8"	-	AD	2,23 \$
03.13.021	KALIN 10"	-	AD	2,82 \$
03.13.022	KALIN 12"	-	AD	4,51 \$



### MİL EĞELERİ



KOD	ÜRÜN ADI	KOLİ	BİRİM	FİYAT
03.13.023	6"	-	AD	1,70 \$
03.13.024	8"	-	AD	2,08 \$
03.13.025	10"	-	AD	2,88 \$
03.13.026	12"	-	AD	4,23 \$



### AĞAÇ TÖRPÜ



KOD	ÜRÜN ADI	KOLİ	BİRİM	FİYAT
03.13.031	8"	-	AD	3,64 \$
03.13.032	10"	-	AD	2,63 \$
03.13.026	12"	-	AD	6,26 \$



### EĞE SAPLARI



KOD	ÜRÜN ADI	KOLİ	BİRİM	FİYAT
03.13.037	ERGONOMİK	600	AD	3,48 ₺
03.13.038	NORMAL	600	AD	2,06 ₺



### ÜÇ KÖŞE TESTERE EĞELERİ



KOD	ÜRÜN ADI	KOLİ	BİRİM	FİYAT
03.13.004	SLİM 4"	-	AD	1,24 \$
03.13.005	SLİM 4,5"	-	AD	1,35 \$
03.13.006	SLİM 5"	-	AD	1,39 \$
03.13.007	SLİM 6"	-	AD	1,62 \$
03.13.008	SLİM 7"	-	AD	1,82 \$
03.13.010	REGULAR 5"	-	AD	1,59 \$
03.13.011	REGULAR 6"	-	AD	1,62 \$
03.13.012	REGULAR 7"	-	AD	1,90 \$
03.13.013	REGULAR 8"	-	AD	2,37 \$
03.13.014	REGULAR 9"	-	AD	2,57 \$



### YARIM YUVARLAK EĞELER



KOD	ÜRÜN ADI	KOLİ	BİRİM	FİYAT
03.13.001	KALIN 8"	-	AD	3,36 \$
03.13.002	KALIN 10"	-	AD	4,46 \$
03.13.003	KALIN 12"	-	AD	6,68 \$



### MOTOR EĞESİ



KOD	ÜRÜN ADI	KOLİ	BİRİM	FİYAT
03.13.027	6" 5/32	-	AD	1,02 \$
03.13.028	8" 3/16	-	AD	1,15 \$
03.13.029	8" 7/32	-	AD	1,15 \$



### YUVARLAK EĞELER



KOD	ÜRÜN ADI	KOLİ	BİRİM	FİYAT
03.13.034	KALIN 8"	-	AD	1,94 \$
03.13.035	KALIN 10"	-	AD	2,63 \$
03.13.036	KALIN 12"	-	AD	6,26 \$





**ÇANAK VİDALI DALGA TELLİ FIRÇA** UGR

KOD	ÜRÜN ADI	KOLİ	BİRİM	FİYAT
03.14.001	65 mm	100	AD	1,93 \$
03.14.002	75 mm	100	AD	2,23 \$
03.14.003	100 mm	60	AD	3,91 \$



**ÇANAK VİDALI BURMA TELLİ FIRÇA** UGR

KOD	ÜRÜN ADI	KOLİ	BİRİM	FİYAT
03.14.006	65 mm	100	AD	2,54 \$
03.14.007	75 mm	100	AD	3,00 \$
03.14.008	100 mm	60	AD	4,77 \$



**DAİRE TEL FIRÇA** UGR

KOD	ÜRÜN ADI	KOLİ	BİRİM	FİYAT
03.14.015	100x30	60	AD	2,90 \$
03.14.016	125x30	60	AD	3,05 \$
03.14.017	150x30	40	AD	6,09 \$
03.14.018	175x30	20	AD	7,37 \$
03.14.019	200x30	20	AD	8,93 \$



**PİMLİ KALEM TEL FIRÇA** UGR

KOD	ÜRÜN ADI	KOLİ	BİRİM	FİYAT
03.14.031	12 mm	50/100	AD	0,58 \$
03.14.032	17 mm	40/400	AD	0,65 \$
03.14.033	24 mm	25/300	AD	0,80 \$
03.14.034	30 mm	25/300	AD	1,13 \$



**PİMLİ DAİRE TEL FIRÇA** UGR

KOD	ÜRÜN ADI	KOLİ	BİRİM	FİYAT
03.14.023	40 mm	24/720	AD	0,67 \$
03.14.024	50 mm	15/450	AD	0,81 \$
03.14.025	63 mm	30/300	AD	0,91 \$
03.14.026	75 mm	25/250	AD	1,32 \$
03.14.027	100 mm	12/120	AD	1,42 \$



**PİMLİ ÇANAK TEL FIRÇA** UGR

KOD	ÜRÜN ADI	KOLİ	BİRİM	FİYAT
03.14.020	50 mm	30/300	AD	1,47 \$
03.14.021	65 mm	15/150	AD	1,78 \$
03.14.022	75 mm	12/120	AD	2,03 \$



**AĞAÇ SAPLI TEL FIRÇA**

KOD	ÜRÜN ADI	KOLİ	BİRİM	FİYAT
03.14.035	3 SIRALI	12/120	AD	0,85 \$
03.14.036	4 SIRALI	12/120	AD	0,90 \$
03.14.037	5 SIRALI	12/120	AD	0,96 \$
03.14.038	6 SIRALI	12/120	AD	1,02 \$

**SU ZIMPARASI**

KOD	ÜRÜN ADI	KOLİ	BİRİM	FİYAT
03.16.043	60	100/1000	AD	0,18 \$
03.16.044	80	100/1000	AD	0,18 \$
03.16.045	100	100/1000	AD	0,18 \$
03.16.046	120	100/1000	AD	0,18 \$
03.16.047	150	100/1000	AD	0,18 \$
03.16.048	180	100/1000	AD	0,18 \$
03.16.049	220	100/1000	AD	0,18 \$
03.16.050	240	100/1000	AD	0,18 \$
03.16.051	280	100/1000	AD	0,18 \$
03.16.052	320	100/1000	AD	0,18 \$
03.16.053	360	100/1000	AD	0,18 \$
03.16.054	400	100/1000	AD	0,18 \$
03.16.055	500	100/1000	AD	0,18 \$
03.16.056	600	100/1000	AD	0,18 \$
03.16.057	800	100/1000	AD	0,18 \$
03.16.058	1000	100/1000	AD	0,18 \$
03.16.059	1200	100/1000	AD	0,18 \$
03.16.060	1500	100/1000	AD	0,18 \$

**PLASTİK SAPLI TEL FIRÇA**

KOD	ÜRÜN ADI	KOLİ	BİRİM	FİYAT
03.14.039	PİRİNÇ	12/120	AD	1,18 \$

**CIRTLI ZIMPARA**

KOD	ÜRÜN ADI	KOLİ	BİRİM	FİYAT
03.16.001	115x40	100/1000	AD	0,12 \$
03.16.002	115x50	100/1000	AD	0,12 \$
03.16.003	115x60	100/1000	AD	0,12 \$
03.16.004	115x80	100/1000	AD	0,12 \$
03.16.005	115x100	100/1000	AD	0,12 \$
03.16.006	115x120	100/1000	AD	0,12 \$
03.16.007	115x150	100/1000	AD	0,12 \$
03.16.008	115x180	100/1000	AD	0,12 \$
03.16.009	115x220	100/1000	AD	0,12 \$
03.16.010	125x40	100/1000	AD	0,14 \$
03.16.011	125x60	100/1000	AD	0,14 \$
03.16.012	125x80	100/1000	AD	0,14 \$
03.16.013	125x100	100/1000	AD	0,14 \$
03.16.014	125x120	100/1000	AD	0,14 \$
03.16.015	150x40	100/1000	AD	0,21 \$
03.16.016	150x60	100/1000	AD	0,21 \$
03.16.017	150x80	100/1000	AD	0,21 \$
03.16.018	150x100	100/1000	AD	0,21 \$
03.16.019	150x120	100/1000	AD	0,21 \$
03.16.020	180x40	100/1000	AD	0,32 \$
03.16.021	180x60	100/1000	AD	0,32 \$
03.16.022	180x80	100/1000	AD	0,32 \$
03.16.023	180x100	100/1000	AD	0,32 \$
03.16.024	180x120	100/1000	AD	0,32 \$
03.16.025	180x240	100/1000	AD	0,32 \$



### RULO ZIMPARA

LSR

KOD	ÜRÜN ADI	KOLİ	BİRİM	FİYAT
03.16.033	200x36 KUM	50/100	AD	2,26 \$
03.16.034	200x40 KUM	50/100	AD	2,26 \$
03.16.035	200x50 KUM	50/100	AD	2,26 \$
03.16.036	200x60 KUM	50/100	AD	2,26 \$
03.16.037	200x80 KUM	50/100	AD	2,26 \$
03.16.038	200x100 KUM	50/100	AD	2,26 \$
03.16.039	200x120 KUM	50/100	AD	2,26 \$
03.16.040	200x150 KUM	50/100	AD	2,26 \$
03.16.041	200x180 KUM	50/100	AD	2,26 \$
03.16.042	200x220 KUM	50/100	AD	2,26 \$



### FLAP DİSK (ALÜMİNYUM OKSİT)

KOD	ÜRÜN ADI	KOLİ	BİRİM	FİYAT
03.15.001	115 X 40 KUM	20/200	AD	0,88 \$
03.15.002	115 X 60 KUM	20/200	AD	0,88 \$
03.15.003	115 X 80 KUM	20/200	AD	0,88 \$
03.15.004	115 X 100 KUM	20/200	AD	0,88 \$
03.15.005	115 X 120 KUM	20/200	AD	0,88 \$
03.15.006	180 X 40 KUM	10/100	AD	3,10 \$
03.15.007	180 X 60 KUM	10/100	AD	3,10 \$
03.15.008	180 X 80 KUM	10/100	AD	3,10 \$
03.15.009	180 X 100 KUM	10/100	AD	3,10 \$
03.15.010	180 X 120 KUM	10/100	AD	3,10 \$



### SUNTA KESME TESTERESİ

KOD	ÜRÜN ADI	KOLİ	BİRİM	FİYAT
03.09.012	115X30 DİŞ	50	AD	3,68 \$
03.09.010	115X40 DİŞ	50	AD	3,68 \$
03.09.002	140X20 DİŞ	50	AD	6,22 \$
03.09.023	160X30 DİŞ	50	AD	5,40 \$
03.09.013	180X24 DİŞ	50	AD	6,47 \$
03.09.005	180X30 DİŞ	50	AD	6,47 \$
03.09.047	180X36 DİŞ	50	AD	12,16 \$
03.09.006	180X40 DİŞ	50	AD	8,23 \$
03.09.011	185X40 DİŞ	50	AD	6,76 \$
03.09.020	190X40 DİŞ	25	AD	10,00 \$
03.09.048	210X30 DİŞ	25	AD	12,05 \$
03.09.008	210X36 DİŞ	25	AD	11,76 \$
03.09.021	230X30 DİŞ	25	AD	12,58 \$
03.09.049	235X34 DİŞ	25	AD	12,15 \$



### CIRTLI ZIMPARA TABANI

KOD	ÜRÜN ADI	KOLİ	BİRİM	FİYAT
03.15.011	115	25/100	AD	1,55 \$
03.15.012	125	25/100	AD	1,64 \$
03.15.013	150	20/80	AD	2,73 \$
03.15.014	180	15/60	AD	3,82 \$



### İNOX KESİCİ

KOD	ÜRÜN ADI	KOLİ	BİRİM	FİYAT
03.08.001	115x1	50/500	AD	0,48 \$



### MTE HSS MATKAP UCU

KOD	ÜRÜN ADI	KOLİ	BİRİM	FİYAT
B00000000200	2,0 mm	10	AD	6,05 ₺
B00000000250	2,5 mm	10	AD	6,19 ₺
B00000000300	3,0 mm	10	AD	6,54 ₺
B00000000350	3,5 mm	10	AD	7,32 ₺
B00000000400	4,0 mm	10	AD	8,43 ₺
B00000000450	4,5 mm	10	AD	9,57 ₺
B00000000500	5,0 mm	10	AD	10,73 ₺
B00000000550	5,5 mm	10	AD	13,21 ₺
B00000000600	6,0 mm	10	AD	14,07 ₺
B00000000650	6,5 mm	10	AD	17,27 ₺
B00000000700	7,0 mm	10	AD	20,45 ₺
B00000000750	7,5 mm	10	AD	23,29 ₺
B00000000800	8,0 mm	10	AD	25,24 ₺
B00000000850	8,5 mm	10	AD	29,22 ₺
B00000000900	9,0 mm	10	AD	32,56 ₺
B00000000950	9,5 mm	10	AD	37,35 ₺
B00000001000	10,0 mm	5	AD	39,26 ₺
B00000001050	10,5 mm	5	AD	46,67 ₺
B00000001100	11,0 mm	5	AD	54,71 ₺
B00000001150	11,5 mm	5	AD	57,68 ₺
B00000001200	12,0 mm	5	AD	63,30 ₺
B00000001250	12,5 mm	5	AD	68,48 ₺
B00000001300	13,0 mm	5	AD	73,11 ₺



### MTE HSS ALTIN SERİ MATKAP UCU

KOD	ÜRÜN ADI	KOLİ	BİRİM	FİYAT
B00005000200	2,0 mm	10	AD	11,51 ₺
B00005000250	2,5 mm	10	AD	11,81 ₺
B00005000300	3,0 mm	10	AD	12,63 ₺
B00005000350	3,5 mm	10	AD	14,67 ₺
B00005000400	4,0 mm	10	AD	17,72 ₺
B00005000450	4,5 mm	10	AD	19,99 ₺
B00005000500	5,0 mm	10	AD	22,60 ₺
B00005000550	5,5 mm	10	AD	27,66 ₺
B00005000600	6,0 mm	10	AD	29,50 ₺
B00005000650	6,5 mm	10	AD	36,22 ₺
B00005000700	7,0 mm	10	AD	43,36 ₺
B00005000750	7,5 mm	10	AD	49,15 ₺
B00005000800	8,0 mm	10	AD	52,74 ₺
B00005000850	8,5 mm	10	AD	61,34 ₺
B00005000900	9,0 mm	10	AD	68,72 ₺
B00005000950	9,5 mm	10	AD	78,10 ₺
B00005001000	10,0 mm	5	AD	83,95 ₺
B00005001050	10,5 mm	5	AD	97,65 ₺
B00005001100	11,0 mm	5	AD	114,00 ₺
B00005001150	11,5 mm	5	AD	120,08 ₺
B00005001200	12,0 mm	5	AD	132,78 ₺
B00005001250	12,5 mm	5	AD	143,33 ₺
B00005001300	13,0 mm	5	AD	152,68 ₺



MAKİNA TAKİM ENDÜSTRİSİ A.Ş.

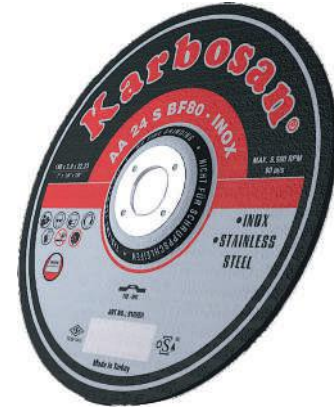

### KARBOSAN İNOX KESME TAŞI

KOD	ÜRÜN ADI	KOLİ	BİRİM	FİYAT
910380	115x1,0	25/300	AD	4,77 ₺



**KARBOSAN KESME TAŞI**

KOD	ÜRÜN ADI	KOLİ	BİRİM	FİYAT
910910	115x3	50/150	AD	5,50 ₺
910040	180x3	25/150	AD	9,66 ₺
910050	230x3	25/100	AD	15,99 ₺

**KARBOSAN TAŞLAMA TAŞI**

KOD	ÜRÜN ADI	KOLİ	BİRİM	FİYAT
91050	115x6,4	25/75	AD	10,51 ₺
910570	180x6,0	10/60	AD	19,90 ₺
910580	230x8,0	10/60	AD	22,50 ₺

**KARBOSAN DÖKÜM KESME TAŞI**

KOD	ÜRÜN ADI	KOLİ	BİRİM	FİYAT
910270	115x2,5	50/150	AD	6,77 ₺
910290	180x3	25/150	AD	12,28 ₺
910300	230x3	25/100	AD	21,44 ₺

**KARBOSAN SABİT TEZGAH KESME TAŞI**

KOD	ÜRÜN ADI	KOLİ	BİRİM	FİYAT
910840	300x3,0	20	AD	30,51 ₺
910860	350x3,5	10	AD	42,64 ₺

**KARBOSAN FLAP DİSK AL.OX.**

KOD	ÜRÜN ADI	KOLİ	BİRİM	FİYAT
K-982930	115x40 KUM	10/120	AD	10,66 ₺
K-982940	115x60 KUM	10/120	AD	10,31 ₺
K-982945	115x80 KUM	10/120	AD	13,36 ₺

**KARBOSAN FLAP DİSK ZR**

KOD	ÜRÜN ADI	KOLİ	BİRİM	FİYAT
930400	115x40 KUM	10/120	AD	12,46 ₺
930410	115x60 KUM	10/120	AD	12,04 ₺
930420	115x80 KUM	10/120	AD	12,04 ₺



**HMP**  
— TOOLS —



**KRESMAN**  
—  
PROFESSIONAL PRODUCTS

**EBRAR HIRDAVAT**



# EL ALETLERİ



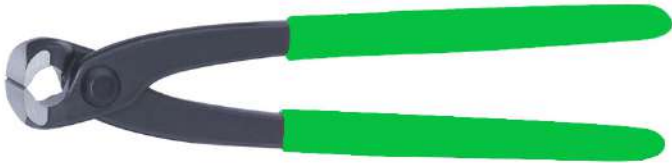

### KOMBİNE PENSE

KOD	ÜRÜN ADI	KOLİ	BİRİM	FİYAT
04.01.001	6" 160 MM	6/60	AD	5,22 \$
04.01.002	7" 180 MM	6/60	AD	5,82 \$
04.01.003	8" 200 MM	6/60	AD	6,10 \$

### YAN KESKİ

KOD	ÜRÜN ADI	KOLİ	BİRİM	FİYAT
04.01.004	5,5" 140 MM	6/60	AD	5,22 \$
04.01.005	6" 160 MM	6/60	AD	5,15 \$
04.01.006	7" 180 MM	6/60	AD	6,10 \$

### KARGABURUN

KOD	ÜRÜN ADI	KOLİ	BİRİM	FİYAT
04.01.007	6" 160 MM	6/60	AD	5,22 \$
04.01.008	7" 180 MM	6/60	AD	5,48 \$
04.01.009	8" 200 MM	6/60	AD	6,10 \$

### KERPETEN

KOD	ÜRÜN ADI	KOLİ	BİRİM	FİYAT
04.01.010	6" 160 MM	6/60	AD	5,35 \$
04.01.011	7" 180 MM	6/60	AD	6,00 \$
04.01.012	8" 200 MM	6/60	AD	6,88 \$

### BETONCU KERPETENİ

KOD	ÜRÜN ADI	KOLİ	BİRİM	FİYAT
04.01.013	9" 225 MM	6/60	AD	6,59 \$
04.01.014	10" 250 MM	6/60	AD	7,29 \$
04.01.015	11" 280 MM	6/60	AD	9,58 \$

### FORT PENSE

KOD	ÜRÜN ADI	KOLİ	BİRİM	FİYAT
04.01.017	240 MM	6/60	AD	9,70 \$

### KURBAĞACIK

KOD	ÜRÜN ADI	KOLİ	BİRİM	FİYAT
04.04.001	6"	6/60	AD	5,13 \$
04.04.002	8"	6/60	AD	7,55 \$
04.04.003	10"	6/60	AD	9,71 \$
04.04.004	12"	6/60	AD	11,87 \$



### MAŞALI BORU ANAHTARI

KOD	ÜRÜN ADI	KOLİ	BİRİM	FİYAT
04.03.001	1"	6/60	AD	13,38 \$
04.03.002	1,5"	6/60	AD	18,82 \$
04.03.003	2"	6/60	AD	34,23 \$



### YILDIZ UÇLU TORNAVİDA HMP

KOD	ÜRÜN ADI	KOLİ	BİRİM	FİYAT
04.02.001	5X100	12/120	AD	1,92 \$
04.02.002	5X125	12/120	AD	1,97 \$
04.02.003	5X150	12/120	AD	2,04 \$
04.02.004	6X100	12/120	AD	2,18 \$
04.02.005	6X125	12/120	AD	2,26 \$
04.02.006	6X150	12/120	AD	2,35 \$
04.02.007	6X175	12/120	AD	2,45 \$
04.02.026	4X100	12/120	AD	0,73 \$



### DÜZ UÇLU TORNAVİDA HMP

KOD	ÜRÜN ADI	KOLİ	BİRİM	FİYAT
04.02.009	3X100	12/120	AD	1,25 \$
04.02.010	5X100	12/120	AD	1,92 \$
04.02.011	5X125	12/120	AD	1,97 \$
04.02.012	5X150	12/120	AD	2,04 \$
04.02.013	6X100	12/120	AD	2,18 \$
04.02.014	6X125	12/120	AD	2,26 \$
04.02.015	6X150	12/120	AD	2,35 \$
04.02.016	6X175	12/120	AD	2,45 \$
04.02.023	4X100	12/120	AD	0,73 \$







### LOKMA UÇLU TORNAVİDA

KOD	ÜRÜN ADI	KOLİ	BİRİM	FİYAT
04.02.028	6 MM	12/120	AD	2,35 \$
04.02.029	7 MM	12/120	AD	2,35 \$
04.02.030	8 MM	12/120	AD	2,35 \$
04.02.031	9 MM	12/120	AD	2,35 \$
04.02.032	10 MM	12/120	AD	2,35 \$
04.02.033	11 MM	12/120	AD	2,47 \$
04.02.034	12 MM	12/120	AD	2,47 \$
04.02.035	13 MM	12/120	AD	2,47 \$
04.02.037	14 MM	12/120	AD	2,47 \$



### TORNAVİDA SETİ

KOD	ÜRÜN ADI	KOLİ	BİRİM	FİYAT
04.02.020	7'Lİ SET	20	AD	8,74 \$

### KONTROL KALEMİ



KOD	ÜRÜN ADI	PAKET	BİRİM	FİYAT
04.02.021	EXPORT	12	AD	0,67 \$

### RASPA ÇEKİÇ



KOD	ÜRÜN ADI	KOLİ	BİRİM	FİYAT
04.09.009	-	12	AD	



### KESER

KOD	ÜRÜN ADI	KOLİ	BİRİM	FİYAT
04.08.001	400 gr	25	AD	3,93 \$

**ÇEKİÇ**

KOD	ÜRÜN ADI	KOLİ	BİRİM	FİYAT
04.09.001	100 GR	12	AD	8,45 ₺
04.09.002	200 GR	12	AD	10,14 ₺
04.09.003	300 GR	12	AD	11,83 ₺
04.09.004	500 GR	12	AD	17,64 ₺
04.09.005	800 GR	6	AD	23,76 ₺
04.09.006	1000 GR	6	AD	26,40 ₺
04.09.007	1500 GR	6	AD	37,17 ₺
04.09.008	2000 GR	6	AD	43,82 ₺

**LASTİK TOKMAK**

KOD	ÜRÜN ADI	KOLİ	BİRİM	FİYAT
04.19.001	40	72	AD	2,76 \$
04.19.002	50	60	AD	3,29 \$
04.19.003	60	48	AD	4,00 \$
04.19.004	70	36	AD	4,59 \$

**AYARLI PENSE**

KOD	ÜRÜN ADI	KOLİ	BİRİM	FİYAT
04.01.016	-	60	AD	8,27 \$

**SPIRAL HAVA HORTUMU**

KOD	ÜRÜN ADI	KOLİ	BİRİM	FİYAT
07.01.153	7,5 MT	50	AD	9,59 \$
07.01.154	15 MT	30	AD	15,34 \$



**CANDAN BORU MAKASI MANUEL**

KOD	ÜRÜN ADI	KOLİ	BİRİM	FİYAT
04.11.005	MANUEL 16-42	48	AD	60,80 \$

**CANDAN BORU MAKASI OTOMATİK**

KOD	ÜRÜN ADI	KOLİ	BİRİM	FİYAT
04.11.004	OTOMATİK 16-42	48	AD	103,72 ₺

**CANDAN PPRC BORU KAYNAK MAKİNASI**

KOD	ÜRÜN ADI	KOLİ	BİRİM	FİYAT
CM-06	SET	1	AD	330,00 ₺

**YAĞDANLIK**

KOD	ÜRÜN ADI	KOLİ	BİRİM	FİYAT
04.16.002	250 ML	60	AD	19,40 ₺
04.12.003	500 ML	60	AD	23,23 ₺

**MAZOT TABANCASI**

KOD	ÜRÜN ADI	KOLİ	BİRİM	FİYAT
04.12.001	-	20	AD	11,32 \$

### BORU MAKASI MANUEL

KOD	ÜRÜN ADI	KOLİ	BİRİM	FİYAT
04.11.005	MANUEL 16-42	48	AD	5,88 \$



### BORU MAKASI OTOMATİK

KOD	ÜRÜN ADI	KOLİ	BİRİM	FİYAT
04.11.004	OTOMATİK 16-42	48	AD	9,24 \$



### PPRC BORU KAYNAK MAKİNASI

KOD	ÜRÜN ADI	KOLİ	BİRİM	FİYAT
04.11.00	-	6	AD	234,61 ₺



### METAL HAVA TABANCASI

KOD	ÜRÜN ADI	KOLİ	BİRİM	FİYAT
04.17.001	KISA	120	AD	3,94 \$
04.17.002	UZUN	120	AD	4,59 \$



### BOYA TABANCASI G70

KOD	ÜRÜN ADI	KOLİ	BİRİM	FİYAT
04.16.001	G70 1,8 MM	20	AD	20,58 \$
04.16.002	E70 1,8 mm	20	AD	21,80 \$
04.16.005	AB 17G 1.3 mm	20	AD	36,46 \$







### ANAHTARLI METAL MANDREN

KOD	ÜRÜN ADI	KOLİ	BİRİM	FİYAT
04.14.001	13 mm 1/2	50	AD	3,55 \$
04.14.002	16 mm 1/2	30	AD	7,37 \$



### OTOMATİK PLASTİK MANDREN

KOD	ÜRÜN ADI	KOLİ	BİRİM	FİYAT
04.14.004	10 mm 1/2	50	AD	3,25 \$
04.14.003	13 mm 1/2	50	AD	4,42 \$



### MANDREN ANAHTARI

KOD	ÜRÜN ADI	KOLİ	BİRİM	FİYAT
04.14.006	16 mm	50	AD	1,13 \$



### ALLEN ANAHTAR SETİ 9'LU

KOD	ÜRÜN ADI	KOLİ	BİRİM	FİYAT
04.02.058	DÜZ	60	AD	6,33 \$



### TORX ALLEN ANAHTAR SETİ 9'LU

KOD	ÜRÜN ADI	KOLİ	BİRİM	FİYAT
04.02.059	TORX	60	AD	6,33 \$

### UGR ŞERİT METRE

UGR

KOD	ÜRÜN ADI	KOLİ	BİRİM	FİYAT
07.01.115	2X13	12/144	AD	1,43 \$
07.01.116	3X16	12/144	AD	1,72 \$
07.01.117	5X16	12/144	AD	2,37 \$
07.01.118	5X19	12/96	AD	2,59 \$
07.01.119	5X25	12/96	AD	3,23 \$
07.01.120	10X25	12/48	AD	6,60 \$



### MUM SİLİKON TABANCASI

KOD	ÜRÜN ADI	KOLİ	BİRİM	FİYAT
04.13.001	10 Watt	12/36	AD	3,60 \$
04.13.002	40 Watt	12/36	AD	5,47 \$
04.13.003	60 Watt	12/36	AD	8,64 \$
04.13.004	80 Watt	12/36	AD	17,55 \$



### MAKARALI KABLO

KOD	ÜRÜN ADI	KOLİ	BİRİM	FİYAT
07.01.109	3X1,5 25 MT	4	AD	124,21 ₺
07.01.110	3X1,5 35 MT	4	AD	143,64 ₺
07.01.111	3X1,5 50 MT	4	AD	181,94 ₺
07.01.112	3X2,5 25 MT	4	AD	164,50 ₺
07.01.113	3X2,5 35 MT	4	AD	205,88 ₺
07.01.139	3X2,5 50 MT	4	AD	297,00 ₺



### KUTULU ANAHTAR TAKIMI 8 PARÇA

KOD	ÜRÜN ADI	KOLİ	BİRİM	FİYAT
04.18.001	6x7-8x9-10-11-12x13-14x15-16x17-18x19-20x22	48	AD	



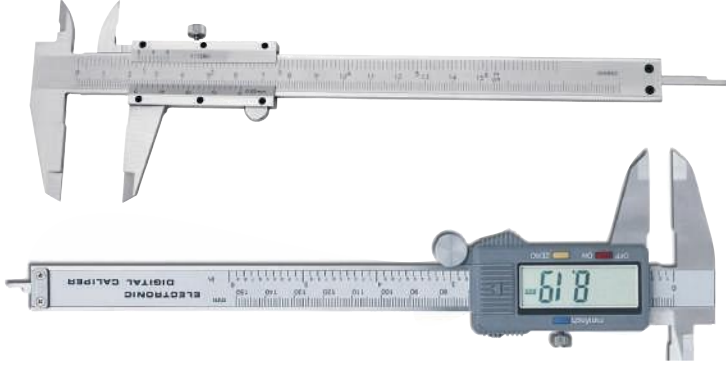

### KUMPAS

KOD	ÜRÜN ADI	KOLİ	BİRİM	FİYAT
04.15.001	MEKANİK 150	36	AD	61,20 ₺
04.15.002	DİJİTAL 150	36	AD	171,60 ₺
04.15.003	DİJİTAL 200	36	AD	



### MASTARLI SU TERAZİSİ



KOD	ÜRÜN ADI	KOLİ	BİRİM	FİYAT
07.01.128	30 CM	10/60	AD	3,97 \$
07.01.129	40 CM	10/60	AD	4,47 \$
07.01.130	50 CM	10/60	AD	4,91 \$
07.01.131	60 CM	10/60	AD	5,41 \$
07.01.132	70 CM	10/60	AD	7,29 \$
07.01.133	80 CM	10/60	AD	7,40 \$

### MIKNATISLI SU TERAZİSİ



MIKNATIS

KOD	ÜRÜN ADI	KOLİ	BİRİM	FİYAT
07.01.134	30 CM	10/60	AD	5,24 \$
07.01.135	40 CM	10/60	AD	5,63 \$
07.01.136	50 CM	10/60	AD	6,07 \$
07.01.137	60 CM	10/60	AD	6,68 \$
07.01.138	80 CM	10/60	AD	7,78 \$

### BMI SU TERAZİSİ

KOD	ÜRÜN ADI	KOLİ	BİRİM	FİYAT
04.26.001	40 CM	12	AD	21,89 €
04.26.002	80 CM	12	AD	27,69 €
04.26.006	50 CM	12	AD	23,39 €
04.26.005	60 CM	12	AD	24,13 €
04.26.003	100 CM	12	AD	30,31 €
04.26.004	120 CM	12	AD	33,87 €
04.26.007	150 CM	12	AD	50,4 €
04.26.008	200 CM	12	AD	62,65 €

**KOLLU MAKAS**

KOD	ÜRÜN ADI	KOLİ	BİRİM	FİYAT
04.01.037	6 MM	2	AD	185,36 ₺
04.01.033	8 MM	2	AD	207,73 ₺
04.01.036	10 MM	2	AD	224,83 ₺
04.01.034	12 MM	2	AD	253,97 ₺
04.01.031	14 MM	2	AD	308,96 ₺
04.01.032	16 MM	2	AD	368,95 ₺

**KLASİK ETRİYE KOLU**

KOD	ÜRÜN ADI	KOLİ	BİRİM	FİYAT
04.01.038	10 MM	6	AD	132,15 ₺
04.01.039	12 MM	6	AD	149,39 ₺

**KESER**

KOD	ÜRÜN ADI	PAKET	BİRİM	FİYAT
04.08.005	400 gr	6	AD	63,75 ₺

**BETONCU KERPETENİ**

KOD	ÜRÜN ADI	PAKET	BİRİM	FİYAT
04.01.019	280 mm	6	AD	85,84 ₺







### FULAZ PENSE

KOD	ÜRÜN ADI	KOLİ	BİRİM	FİYAT
YKF0020	160 mm	72	AD	50,21 ₺
YKF0021	180 mm	72	AD	53,56 ₺



### FULAZ YANKESKİ

KOD	ÜRÜN ADI	KOLİ	BİRİM	FİYAT
YKF0022	140 mm	72	AD	43,71 ₺
YKF0023	160 mm	72	AD	48,70



### FULAZ KESER

KOD	ÜRÜN ADI	KOLİ	BİRİM	FİYAT
YKF0027	400 gr	48	AD	39,12 ₺



### FULAZ ÇAPA

KOD	ÜRÜN ADI	KOLİ	BİRİM	FİYAT
YKF0029	ÇATAL	24	AD	16,00 ₺
YKF0030	SAPLI ÇATAL	12	AD	19,43 ₺
YKF0031	SİVRİ	24	AD	16,00 ₺
YKF0032	SAPLI SİVRİ	12	AD	19,43 ₺



**FAST  
FIX**



- HIZLI VE GÜÇLÜ İLK TUTUNMA (İLK 5 SANİYE)
- GÜÇLÜ YAPIŞMA
- ESNEK BAĞLANTI
- SU GEÇİRMEZ
- UV'YE DAYANIKLIDIR
- İÇ VE DIŞ MEKANLARDA KULLANILABİLİR





## 256 Multisistem Merkezi Çelik Kapı Kiliti

Tek anahtar ile 14 noktadan kilitleme yapar. Hizmetçi kilidi sayesinde yetkilendirilen (temizlikçi gibi) kişiler, ana kilit kullanılmadığı zaman kapıyı açabilir.





# MOBİLYA AKSESUARİ VE KİLİTLER







### KALE SİLİNDİRLİ DAİRE KİLİDİ

KOD	ÜRÜN ADI	KOLİ	BİRİM	FİYAT
152R3500001	35mm SARI	30	AD	106,58 ₺
152R3500002	35mm NİKEL	30	AD	106,58 ₺
152R3500004	35mm OVAL NİKEL	30	AD	106,58 ₺
152R4000113	40mm SARI	30	AD	109,35 ₺
152R4000114	40mm NİKEL	30	AD	109,35 ₺
152R4000116	40mm OVAL NİKEL	30	AD	109,35 ₺
152R4500260	45mm NİKEL	30	AD	112,11 ₺
152R4500261	45mm OVAL- NİKEL	30	AD	112,11 ₺
152R4500264	3 MR NİKEL	30	AD	88,85 ₺
152R4500267	2000 KİLİT NİKEL	30	AD	129,69 ₺
152RP450002	45mm 18 MM AYNA OVAL NİKEL	30	AD	112,11 ₺

### KALE ODA GÖMME KİLİDİ

KOD	ÜRÜN ADI	KOLİ	BİRİM	FİYAT
141R4500001	45mm NİKEL	40	AD	38,24 ₺
151R3500001	35mm SARI	40	AD	32,87 ₺
151R3500002	35mm NİKEL	40	AD	32,87 ₺
151R3500004	35mm OVAL NİKEL	40	AD	32,87 ₺
151R4000027	40mm OVAL NİKEL	40	AD	32,87 ₺
151R4000028	40mm NİKEL	40	AD	32,87 ₺

### KALE PRAZİS SİLİNDİRLİ EMNİYET KİLİDİ

KOD	ÜRÜN ADI	KOLİ	BİRİM	FİYAT
157F0000001	35mm 2 Turlu	30	AD	71,92 ₺
156F0000001	Kilidi 45mm (3 Anah)	30	AD	63,62 ₺
189F0000005	189 3 MF NİKEL	30	AD	69,16 ₺

### KALE TRAJLI KİLİT

KOD	ÜRÜN ADI	KOLİ	BİRİM	FİYAT
157A0000070	52mm SİYAH	30	AD	91,77 ₺
157A0000116	52mm SİYAH EKO	30	AD	63,46 ₺
157AE000001	ESKİ TİP 52 mm SİYAH	30	AD	91,77 ₺
157C0000001	52mm SİYAH	30	AD	90,80 ₺
157EL000006	52mm SATEN NİKEL SABİT	30	AD	216,09 ₺
357M0000001	Elektrikli Otomat 52mm SİYAH	16	AD	261,49 ₺
357M0000002	Elektrikli Otomat 52mm PASLAN	16	AD	332,93 ₺

### KALE BANYO-WC KİLİDİ

KOD	ÜRÜN ADI	KOLİ	BİRİM	FİYAT
169R3500002	35mm NİKEL	40	AD	32,87 ₺
169R3500004	35mm OVAL NİKEL	40	AD	32,87 ₺
169R4000025	40mm SARI	40	AD	32,87 ₺
169R4000028	40mm NİKEL	40	AD	32,87 ₺
169R4000030	40mm OVAL NİKEL	40	AD	32,87 ₺

### KALE PVC DOĞRAMA KAPI KİLİDİ

KOD	ÜRÜN ADI	KOLİ	BİRİM	FİYAT
269P2000001	Banyo WC Kilidi 20mm	40	AD	30,92 ₺
269P2500001	WC Kilidi 25mm	40	AD	30,92 ₺
269P3500001	WC Kilidi 35mm	40	AD	30,92 ₺

### KALE ALÜMİNYUM DOĞRAMA KAPI KİLİDİ

KOD	ÜRÜN ADI	KOLİ	BİRİM	FİYAT
15320000002	Dar Tip 20mm NİKEL	30	AD	76,32 ₺
15320000013	20mm NİKEL	30	AD	32,71 ₺
15325000002	Standart Daire Kilidi Dar Tip 25mm NİKEL	30	AD	76,32 ₺
15325000011	DAR TİP 25mm NİKEL GÖVDE 153U	30	AD	32,71 ₺
15330000004	Alüminyum Doğrama Kapı Kilidi 30 mm KROM GÖVDE	30	AD	32,71 ₺
15330000034	Alüminyum Doğrama için Silindirli Kapı Kilidi 30mm	30	AD	92,91 ₺
15335000042	Alüminyum Doğrama için Silindirli Kapı Kilidi 35mm	30	AD	92,91 ₺
153P3500001	PVC Doğrama için Silindirli Kapı Kilidi 35mm	30	AD	30,92 ₺
15520000001	Stand. Sil. Daire Kilidi Makaralı 20mm SAR	30	AD	76,32 ₺
15520000002	Stand. Sil. DAİR KİLİDİ MAKARALI 20mm NİK. 155U	30	AD	76,32 ₺
15525000002	Stand. Sil. Daire Kilidi Makaralı 25mm NİKEL	30	AD	76,32 ₺



### KALE BARELLER



KOD	ÜRÜN ADI	KOLİ	BİRİM	FİYAT
164BME00001	Bilyalı Mandallı Silindir Çelik Pimli 68mm SARI	12	AD	108,53 ₺
164BME00007	Bilyalı Mandallı Silindir Çelik Pimli 68mm SATEN	12	AD	108,53 ₺
164BME00060	Bilyalı Mandallı Silindir Çelik Pimli 90mm SATEN	12	AD	134,57 ₺
164BNE00006	Bilyalı Silindir Çelik Pimli 68mm SATEN	12	AD	94,54 ₺
164BNE00008	Bilyalı Silindir Çelik Pimli 68mm SARI	12	AD	94,54 ₺
164BNE00062	Bilyalı Silindir Çelik Pimli 90mm SATEN	12	AD	120,58 ₺
164GMC00006	Standart Mandallı Silindir Çelik Pimli 68mm SATEN	12	AD	64,44 ₺
164GNC00005	Stand. Sil. Çelik Pimli 62mm SATEN	24	AD	46,70 ₺
164GNC00008	Stand. Sil. Çelik Pimli 62mm SARI	24	AD	46,70 ₺
164GNC00019	Stand. Sil. Çelik Pimli 68mm SARI	24	AD	50,44 ₺
164GNC00028	Stand. Sil. Çelik Pimli 76mm SATEN	24	AD	55,81 ₺
164GNC00076	Stand. Sil. Çelik Pimli 83mm SARI	24	AD	64,44 ₺
164GNC00088	Stand. Sil. Çelik Pimli 90mm SATEN	24	AD	67,04 ₺
164GNC00123	Stand. Sil. Çelik Pimli 83mm SATEN	24	AD	64,44 ₺
164GNC00129	Stand. Sil. Çelik Pimli 68mm SATEN	24	AD	50,44 ₺
164KTBS0004	Tuzaklı Sistem Çelik Pimli Silindir 68mm SATEN	12	AD	97,31 ₺
164SNC00005	Sistem Silindir Çelik Pimli 68mm SATEN	12	AD	69,48 ₺
164SNC00007	Sistem Silindir Çelik Pimli 90mm SARI	12	AD	80,55 ₺
164SNC00062	Sistem Silindir Çelik Pimli 90mm NİKEL	12	AD	96,66 ₺

### KALE TOPUZLU KİLİT

KOD	ÜRÜN ADI	KOLİ	BİRİM	FİYAT
KD-040/35-320	GİRİŞ TİPİ 60-70 mm EZ-SET	30	AD	99,75 ₺
KD-040/36-320	GİRİŞ TİPİ 60-70 mm ARCO	30	AD	77,96 ₺

**KALE KAPI HİDROLİĞİ**

KOD	ÜRÜN ADI	KOLİ	BİRİM	FİYAT
KD-002/20-002	HİDROLİNK GÜMÜŞ NO:3	10	AD	158,09 ₺







### YUMA CERMAN BAREL

KOD	ÜRÜN ADI	PAKET	BİRİM	FİYAT
YM-B68	68 mm SARI	24	AD	34,73 ₺
YM-B68S	68 mm SATEN	24	AD	36,09 ₺



### YUMA BİLYALI BAREL

KOD	ÜRÜN ADI	PAKET	BİRİM	FİYAT
YM-B68BS	68 mm SATEN	12	AD	44,06 ₺
YM-B68BTS	68 mm SATEN TUZAKLI	12	AD	45,62 ₺
YM-B68BT	68 mm SARI TUZAKLI	12	AD	44,06 ₺



### YUMA MANDALLI BAREL

KOD	ÜRÜN ADI	KOLİ	BİRİM	FİYAT
YM-B68MS	68 mm Cerman Mandalli Saten	12	AD	43,74 ₺
YM-B68M	68 mm Cerman Mandalli Sari	12	AD	42,25 ₺
YM-B68BMS	68 mm Bilyali Mandalli Saten	12	AD	52,62 ₺
YM-B68BM	68 mm Bilyali Mandalli Sari	12	AD	51,06 ₺
YM-B68BTMS	68 mm Bilyali Tuzakli Mandalli Saten	12	AD	54,17 ₺



### YUMA PİRİNÇ ASMA KİLİT

KOD	ÜRÜN ADI	KOLİ	BİRİM	FİYAT
YM-2032	32 MM	12/120	AD	27,86 ₺
YM-2040	40 MM	12/120	AD	34,86 ₺
YM-2050	50 MM	6/60	AD	43,74 ₺
YM-2060	60 MM	6/60	AD	54,76 ₺
YM-2063	63 MM	6/60	AD	64,28 ₺
YM-2032L	UZUN 32 MM	12/120	AD	29,48 ₺
YM-2040L	UZUN 40 MM	12/120	AD	37,00 ₺
YM-2050L	UZUN 50 MM	6/60	AD	46,4 ₺
YM-2060L	UZUN 60 MM	6/60	AD	57,93 ₺

### YUMA GRİ DÖKÜM ASMA KİLİT

KOD	ÜRÜN ADI	KOLİ	BİRİM	FİYAT
YM-1020	20 mm	12/120	AD	4,83 ₺
YM-1025	25 mm	12/120	AD	5,61 ₺
YM-1032	32 mm	6/60	AD	7,05 ₺
YM-1038	38 mm	6/60	AD	9,56 ₺
YM-1050	50 mm	6/60	AD	16,85 ₺
YM-1063	63 mm	12/120	AD	24,49 ₺
YM1038L	38 mm UZUN	12/120	AD	10,33 ₺
YM1050L	50 mm UZUN	6/60	AD	17,91 ₺



### YUMA SARI KAPLAMA ASMA KİLİT

KOD	ÜRÜN ADI	KOLİ	BİRİM	FİYAT
YM-1025	25 mm	12/120	AD	5,61 ₺
YM-1032	32 mm	12/120	AD	7,05 ₺
YM-1038	38 mm	6/60	AD	9,56 ₺
YM-1050	50 mm	6/60	AD	16,85 ₺
YM-1063	63 mm	6/60	AD	24,49 ₺
YM1038L	38 mm UZUN	12/120	AD	10,33 ₺
YM1050L	50 mm UZUN	12/120	AD	17,91 ₺



### YUMA KAYAR MİLLİ ASMA KİLİT

KOD	ÜRÜN ADI	KOLİ	BİRİM	FİYAT
YM-3070	70 mm	6/48	AD	72,96 ₺
YM-3080	80 mm	6/48	AD	76,59 ₺
YM-3068	68 mm (YENİ)	12/120	AD	65,60 ₺
YM-3079	79 mm (YENİ)	12/120	AD	71,54 ₺





### YUMA TRAJLI KİLİT

KOD	ÜRÜN ADI	KOLİ	BİRİM	FİYAT
YM-600	OVAL	30	AD	50,93 ₺
YM-602	KARE	30	AD	50,93 ₺
YM-609	ELEKTRİKLİ	12	AD	168,48 ₺



### YUMA EMNİYET KELEPÇESİ

KOD	ÜRÜN ADI	KOLİ	BİRİM	FİYAT
YM-701	SARI	60	AD	27,22 ₺
YM-702	SATEN	60	AD	27,22 ₺

### YUMA GÖMME KİLİT

KOD	ÜRÜN ADI	KOLİ	BİRİM	FİYAT
YM-603	Silindirli Daire Kilidi Rulmanlı Nikel 35 mm		AD	66,10 ₺
YM-605	35 mm WC Kilidi Rulmanlı Nikel		AD	28,77 ₺



### YUMA OTO EMNİYET KİLİDİ

KOD	ÜRÜN ADI	KOLİ	BİRİM	FİYAT
YM-603	-		AD	66,10 ₺



### YUMA PANİKBAR

KOD	ÜRÜN ADI	KOLİ	BİRİM	FİYAT
YM-603	-		AD	112,75 ₺







### ASMA KİLİT SARI KAPLAMA

KOD	ÜRÜN ADI	KOLİ	BİRİM	FİYAT
05.26.019	20 MM	12/240	AD	0,70 \$
05.26.001	25 MM	6/240	AD	0,75 \$
05.26.002	32 MM	6/240	AD	1,35 \$
05.26.003	38 MM	6/240	AD	1,59 \$
05.26.004	50 MM	6/240	AD	2,39 \$
05.26.005	63 MM	6/240	AD	3,46 \$
05.26.005	32 MM UZUN	6/240	AD	1,43 \$



### ASMA KİLİT DÖKÜM GRİ

KOD	ÜRÜN ADI	KOLİ	BİRİM	FİYAT
05.26.020	20 MM	6/600	AD	0,52 \$
05.26.010	25 MM	6/240	AD	0,57 \$
05.26.011	32 MM	6/240	AD	1,14 \$
05.26.012	38 MM	6/240	AD	1,46 \$
05.26.013	50 MM	6/60	AD	2,29 \$
05.26.014	63 MM	6/60	AD	3,35 \$



### BRAVO KAPI KOLU

KOD	ÜRÜN ADI	KOLİ	BİRİM	FİYAT
05.29.001	ODA NİKEL	6	AD	15,60 ₺
05.29.002	WC NİKEL	6	AD	18,00 ₺
05.29.003	YALE NİKEL	6	AD	15,60 ₺

### BRAVO ROZETLİ KAPI KOLU

KOD	ÜRÜN ADI	KOLİ	BİRİM	FİYAT
05.29.007	ODA NİKEL	6	AD	20,40 ₺
05.29.008	YALE NİKEL	6	AD	20,40 ₺



### ALÜMİNYUM VE CAM KAPI EMNİYET APARATI

KOD	ÜRÜN ADI	KOLİ	BİRİM	FİYAT
05.31.007	-	24	AD	55,44 ₺

**TOPUZLU KİLİT**

KOD	ÜRÜN ADI	KOLİ	BİRİM	FİYAT
05.25.001	SATEN ODA	30	AD	10,04 \$

**ASPIRATÖR BORUSU**

KOD	ÜRÜN ADI	KOLİ	BİRİM	FİYAT
03.07.078	120 x 2 mt	100	AD	10,20 \$



**PERGULA AYIĞI**

KOD	ÜRÜN ADI	KOLİ	BİRİM	FİYAT
05.30.001	-	24	AD	15,71 ₺

**KAPI HİDROLİĞİ**

KOD	ÜRÜN ADI	KOLİ	BİRİM	FİYAT
05.24.001	NO:2 / 20-45 kg	10	AD	18,31 \$
05.24.002	NO:3 / 40-65 kg	10	AD	22,95 \$
05.24.003	NO:4 / 60-85 kg	10	AD	28,78 \$

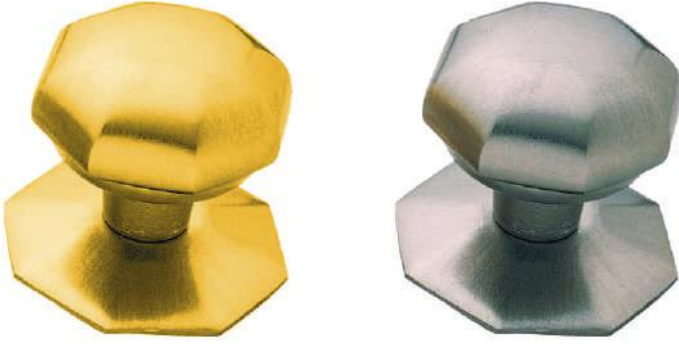



### KAPI TOKMAK

KOD	ÜRÜN ADI	KOLİ	BİRİM	FİYAT
05.18.006	ALBİRİFİN SATEN	12	AD	17,80 ₺
05.18.005	NİKEL	12	AD	17,80 ₺



### KAPI TAMPONU

KOD	ÜRÜN ADI	KOLİ	BİRİM	FİYAT
05.18.001	SATEN	50	AD	3,30 ₺



### PİTON

KOD	ÜRÜN ADI	KOLİ	BİRİM	FİYAT
05.07.001	16X30	144	AD	23,76 ₺
05.07.002	17X50	144	AD	21,12 ₺
05.07.003	18X60	144	AD	23,76 ₺
05.07.004	19X70	144	AD	26,40 ₺
05.07.005	20X80	144	AD	33,00 ₺
05.07.006	21X80	100	AD	0,29 ₺
05.07.007	21X100	100	AD	0,33 ₺
05.07.008	22X130	100	AD	0,46 ₺
05.07.009	23X150	100	AD	0,66 ₺
05.07.010	24X175	100	AD	0,79 ₺



### TAS MENTEŞE

KOD	ÜRÜN ADI	KOLİ	BİRİM	FİYAT
	DÜZ	1	AD	3,26 ₺
	DEVE BOYNU	1	AD	3,34 ₺



### SANDIK ASKISI

KOD	ÜRÜN ADI	KOLİ	BİRİM	FİYAT
05.01.001	NO:25	12/60	AD	21,12 ₺
05.01.002	NO:30	12/60	AD	22,44 ₺
05.01.003	NO:35	12/60	AD	26,40 ₺



### MİL MENTEŞE

KOD	ÜRÜN ADI	KOLİ	BİRİM	FİYAT
05.06.001	10 MM	60	AD	2,11 ₺
05.06.002	12 MM	60	AD	2,38 ₺
05.06.003	14 MM	50	AD	3,04 ₺
05.06.004	16 MM	40	AD	3,96 ₺
05.06.005	18 MM	28	AD	5,02 ₺
05.06.006	20 MM	24	AD	6,60 ₺
05.06.007	22 MM	20	AD	8,18 ₺
05.06.008	24 MM	15	AD	10,30 ₺
05.06.009	26 MM	12	AD	11,88 ₺
05.06.010	30 MM	12	AD	21,12 ₺



### DEMİR DOĞRAMA SÜRGÜSÜ

KOD	ÜRÜN ADI	KOLİ	BİRİM	FİYAT
05.03.001	NO:18	12	DZ	63,36 ₺



### LÜKS MAVZER SÜRGÜ

KOD	ÜRÜN ADI	KOLİ	BİRİM	FİYAT
05.02.001	NO:4	12	DZ	35,64 ₺
05.02.002	NO:6	12	DZ	36,96 ₺
05.02.003	NO:8	12	DZ	38,28 ₺
05.02.004	NO:10	12	DZ	43,56 ₺
05.02.005	NO:12	12	DZ	44,88 ₺
05.02.006	NO:14	12	DZ	47,52 ₺
05.02.007	NO:16	12	DZ	52,80 ₺

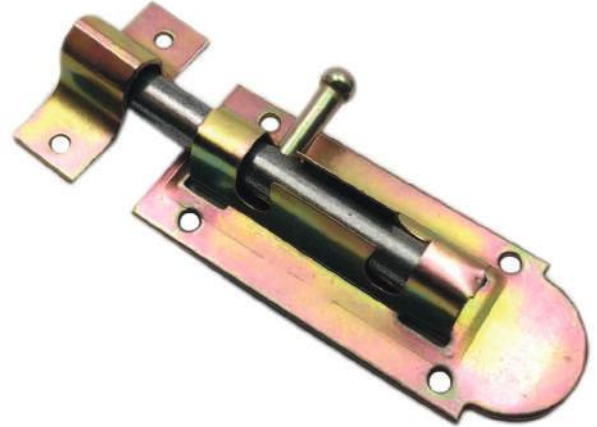

### YAYLI SÜRGÜ

KOD	ÜRÜN ADI	KOLİ	BİRİM	FİYAT
05.20.005	10 cm	12	AD	9,55 ₺
05.20.006	15 cm	12	AD	11,24 ₺
05.20.007	20 cm	12	AD	14,61 ₺
05.20.008	25 cm	12	AD	16,85 ₺
05.20.009	30 cm	12	AD	18,00 ₺



### YAYLI MAVZER SÜRGÜ

KOD	ÜRÜN ADI	KOLİ	BİRİM	FİYAT
05.20.001	NO:15	12/60	DZ	36,96 ₺

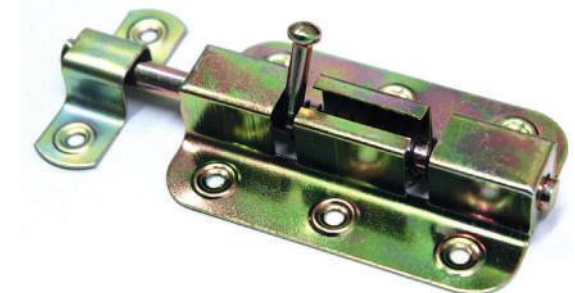



**ÇEKMECE KİLİDİ EKO**

KOD	ÜRÜN ADI	KOLİ	BİRİM	FİYAT
05.27.002	EKO	12/240	AD	0,83 \$

**ÇEKMECE KİLİDİ**

KOD	ÜRÜN ADI	KOLİ	BİRİM	FİYAT
05.27.004	38 mm	12/240	AD	1,80 \$

**ÇEKMECE KİLİDİ**

KOD	ÜRÜN ADI	KOLİ	BİRİM	FİYAT
05.27.008	OVAL	12/240	AD	1,20 \$

**İSPANYOLET KİLİT**

KOD	ÜRÜN ADI	KOLİ	BİRİM	FİYAT
05.27.010	120 cm	12/240	AD	9,19 \$

**ÇEKMECE KİLİDİ**

KOD	ÜRÜN ADI	KOLİ	BİRİM	FİYAT
05.27.009	105 (İTMELİ)	12/240	AD	1,44 \$

**ÇEKMECE KİLİDİ****UGR**

KOD	ÜRÜN ADI	KOLİ	BİRİM	FİYAT
05.27.013	208 (SÜRGÜLÜ)	12/240	AD	1,75 \$

**ÇEKMECE KİLİDİ****UGR**

KOD	ÜRÜN ADI	KOLİ	BİRİM	FİYAT
05.27.022	YUVARLAK	12/240	AD	1.35 \$

**ÇEKMECE KİLİDİ****UGR**

KOD	ÜRÜN ADI	KOLİ	BİRİM	FİYAT
05.27.021	502 (YAYLI)	12/240	AD	2,09 \$

**MERKEZİ KİLİT SETİ 60 CM****UGR**

KOD	ÜRÜN ADI	KOLİ	BİRİM	FİYAT
05.27.011	19 mm	12/120	AD	2,80 \$
05.27.012	16 mm	12/120	AD	2,68 \$

**CAM KİLİDİ****UGR**

KOD	ÜRÜN ADI	KOLİ	BİRİM	FİYAT
05.27.016	407 TEKLİ	12/240	AD	1,92 \$
05.27.018	225	12/240	AD	1,73 \$





### YAPRAK MENTEŞE

KOD	ÜRÜN ADI	KOLİ	BİRİM	FİYAT
05.21.001	15X25	150	DZ	0,44 ₺
05.21.002	15X35	150	DZ	0,50 ₺
05.21.003	15X45	100	DZ	0,61 ₺
05.21.004	15X55	100	DZ	0,71 ₺
05.21.005	15X65	100	DZ	0,84 ₺
05.21.006	15X75	100	DZ	0,95 ₺
05.21.007	20X25	100	DZ	0,82 ₺
05.21.008	20X35	100	DZ	0,86 ₺
05.21.009	20X45	100	DZ	0,95 ₺
05.21.010	20X55	100	DZ	1,06 ₺
05.21.011	20X65	50	DZ	1,19 ₺
05.21.012	20X75	50	DZ	1,43 ₺
05.21.013	20X85	50	DZ	1,58 ₺
05.21.014	20X95	50	DZ	1,85 ₺



### YAPRAK MENTEŞE

KOD	ÜRÜN ADI	KOLİ	BİRİM	FİYAT
05.04.001	NO:2	12	DZ	23,76 ₺
05.04.002	NO:2,5	12	DZ	26,40 ₺
05.04.003	NO:3	12	DZ	31,68 ₺
05.04.004	NO:3,5	12	DZ	48,84 ₺
05.04.005	NO:4	12	DZ	63,36 ₺



### LÜX RAF ALTI

KOD	ÜRÜN ADI	KOLİ	BİRİM	FİYAT
05.19.001	5X6	12	DZ	39,60 ₺
05.19.002	6X8	12	DZ	50,16 ₺
05.19.003	7X9	12	DZ	59,40 ₺
05.19.004	8X10	12	DZ	68,64 ₺
05.19.005	10X12	12	DZ	76,56 ₺
05.19.006	12X14	12	DZ	95,04 ₺

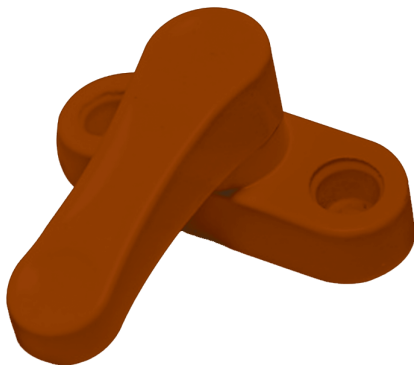

### PVC EMNİYET KİLİDİ (ZAMAK)

KOD	ÜRÜN ADI	KOLİ	BİRİM	FİYAT
05.32.005	BEYAZ	300	DZ	13,20
05.32.006	KAHVE	300	DZ	13,20

### GAZLI PİSTON

KOD	ÜRÜN ADI	KOLİ	BİRİM	FİYAT
	80 N	100	AD	9,60 ₺
	100 N	100	AD	9,60 ₺
	120 N	100	AD	9,60 ₺
	KISA 60 N	100	AD	9,60 ₺
	KISA 80 N	100	AD	9,60 ₺
	KISA 100 N	100	AD	9,60 ₺



### LALE MAKAS

KOD	ÜRÜN ADI	KOLİ	BİRİM	FİYAT
	-	100	AD	📞



### YER TAMPONU

KOD	ÜRÜN ADI	KOLİ	BİRİM	FİYAT
	35 mm / SARI	50	AD	
	35 mm / KROM	50	AD	
	35 mm / SATEN	50	AD	
	50 mm / SARI	50	AD	
	50 mm / KROM	50	AD	
	50 mm / SATEN	50	AD	



### KAPI TAMPONU

KOD	ÜRÜN ADI	KOLİ	BİRİM	FİYAT
	SARI	50	AD	3,30 ₺
	KROM	50	AD	3,30 ₺
	SATEN	50	AD	3,30 ₺
	BEYAZ	50	AD	3,30 ₺







#### KAPI KOLU TAMPONU

KOD	ÜRÜN ADI	PAKET	BİRİM	FİYAT
05.18.008	-	250	AD	108,00 ₺



#### METAL SARIKLI ASKILIK

KOD	ÜRÜN ADI	KOLİ	BİRİM	FİYAT
05.18.004	ALBİRİFİN	100	AD	2,65 ₺
05.18.007	SATEN	100	AD	2,65 ₺



#### DOLAP ASKI ELEMANI

KOD	ÜRÜN ADI	KOLİ	BİRİM	FİYAT
	1.20 BEYAZ	25	AD	0,70 ₺
	1.20 KAHVE	25	AD	0,70 ₺
	1.20 KREM	25	AD	0,70 ₺



#### PLASTİK BAZA AYAĞI

KOD	ÜRÜN ADI	PAKET	BİRİM	FİYAT
-	10-15	100	AD	1,40 ₺



# BAĞLANTI ELEMENLARI





### SUNTA VİDASI



KOD	ÜRÜN ADI	KOLİ	BİRİM	FİYAT
06.01.001	2.5X16	1000/45000	AD	0,00378 \$
06.01.002	3.0X13	1000/28000	AD	0,00379 \$
06.01.003	3.0X16	1000/28000	AD	0,00405 \$
06.01.004	3.0X20	1000/24000	AD	0,00461 \$
06.01.005	3.0X25	1000/24000	AD	0,00540 \$
06.01.006	3.5X13	1000/28000	AD	0,00398 \$
06.01.007	3.5X16	1000/28000	AD	0,00457 \$
06.01.008	3.5X18	1000/28000	AD	0,00495 \$
06.01.009	3.5X20	1000/24000	AD	0,00559 \$
06.01.010	3.5X25	1000/16000	AD	0,00618 \$
06.01.011	3.5X30	1000/12000	AD	0,00728 \$
06.01.012	3.5X35	1000/10000	AD	0,00841 \$
06.01.013	3.5X40	1000/10000	AD	0,00939 \$
06.01.014	3.5X45	1000/10000	AD	0,01058 \$
06.01.015	3.5X50	500/5000	AD	0,02288 \$
06.01.016	4.0X16	1000/24000	AD	0,00597 \$
06.01.017	4.0X18	1000/24000	AD	0,00624 \$
06.01.018	4.0X20	1000/24000	AD	0,00648 \$
06.01.019	4.0X25	500/12000	AD	0,01554 \$
06.01.020	4.0X30	1000/10000	AD	0,00884 \$
06.01.021	4.0X35	1000/10000	AD	0,01014 \$
06.01.022	4.0X40	500/6000	AD	0,02316 \$
06.01.023	4.0X45	500/5000	AD	0,02496 \$
06.01.024	4.0X50	500/6000	AD	0,02796 \$
06.01.025	4.0X60	500/4000	AD	0,03536 \$
06.01.026	4.0X70	500/4000	AD	0,04160 \$
06.01.049	4.5X35	500/5000	AD	0,02028 \$
06.01.027	4.5X40	500/5000	AD	0,03086 \$
06.01.028	4.5X45	500/5000	AD	0,03320 \$
06.01.029	4.5X50	500/5000	AD	0,03640 \$
06.01.030	4.5X60	500/3000	AD	0,04612 \$
06.01.031	5.0X30	500/5000	AD	0,03050 \$
06.01.032	5.0 X35	500/5000	AD	0,03424 \$
06.01.033	5.0 X40	500/5000	AD	0,03606 \$
06.01.034	5.0 X45	500/5000	AD	0,04092 \$

### SUNTA VİDASI



KOD	ÜRÜN ADI	KOLİ	BİRİM	FİYAT
06.01.035	5.0 X50	500/4000	AD	0,04578 \$
06.01.036	5.0 X60	200/2400	AD	0,13005 \$
06.01.037	5.0X70	200/2400	AD	0,15605 \$
06.01.038	5.0 X80	200/2000	AD	0,18205 \$
06.01.039	5.0 X100	100/1200	AD	0,54790 \$
06.01.040	6.0 X40	200/2000	AD	0,15000 \$
06.01.041	6.0 X50	200/2000	AD	0,17425 \$
06.01.042	6.0 X60	200/2000	AD	0,20285 \$
06.01.043	6.0 X70	100/1600	AD	0,45770 \$
06.01.044	6.0X80	100/1000	AD	0,53230 \$
06.01.045	6.0X100	100/1000	AD	0,65190 \$
06.01.046	6.0X120	100/1000	AD	0,83580 \$
06.01.047	6.0X150	100/1000	AD	1,26580 \$



### BULDEKS VİDA



KOD	ÜRÜN ADI	KOLİ	BİRİM	FİYAT
06.07.003	7.5X60	1000/6000	AD	0,05 \$
06.07.004	7.5X80	1000/6000	AD	0,07 \$
06.07.005	7.5X100	800/4800	AD	0,08 \$
06.07.006	7.5X120	650/3900	AD	0,10 \$
06.07.007	7.5X150	300/3000	AD	0,14 \$



### GİJON

KOD	ÜRÜN ADI	KOLİ	BİRİM	FİYAT
06.40.001	M6 X1000	50	AD	2,95 ₺
06.40.002	M8 X1000	50	AD	4,56 ₺
06.40.003	M10 X1000	30	AD	7,20 ₺
06.40.004	M12 X1000	30	AD	11,10 ₺
06.40.005	M14 X1000	25	AD	14,70 ₺

**MATKAP UÇLU VİDA (YHB) LGR**

KOD	ÜRÜN ADI	PAKET	BİRİM	FİYAT
06.02.001	3.9X13	1000	AD	0,00677 \$
06.02.002	3.9X16	1000	AD	0,00751 \$
06.02.003	3.9X19	1000	AD	0,00965 \$
06.02.004	3.9X22	1000	AD	0,00930 \$
06.02.005	3.9X25	1000	AD	0,01140 \$
06.02.006	3.9X32	1000	AD	0,01268 \$
06.02.007	3.9X38	1000	AD	0,01479 \$
06.02.008	4.2X16	1000	AD	0,00906 \$
06.02.009	4.2X19	1000	AD	0,01004 \$
06.02.010	4.2X22	1000	AD	0,01078 \$
06.02.011	4.2X25	1000	AD	0,01279 \$
06.02.012	4.2X32	1000	AD	0,01588 \$
06.02.013	4.2X38	1000	AD	0,01813 \$
06.02.014	4.2X45	1000	AD	0,02028 \$
06.02.015	4.8X19	1000	AD	0,01472 \$
06.02.016	4.8X25	1000	AD	0,01515 \$
06.02.017	4.8X32	1000	AD	0,02131 \$
06.02.018	4.8X38	1000	AD	0,02480 \$
06.02.019	4.8X45	1000	AD	0,03022 \$
06.02.020	4.8X50	1000	AD	0,03138 \$
06.02.021	4.8X60	1000	AD	0,03759 \$
06.02.022	4.8X70	1000	AD	0,04264 \$
06.02.023	4.8X80	1000	AD	0,04648 \$

**MATKAP UÇLU ALÇIPAN VİDASI LGR**

KOD	ÜRÜN ADI	PAKET	BİRİM	FİYAT
06.05.001	3,5x25	1000/12000	AD	0,01019 \$
06.05.002	3,5x35	1000/8000	AD	0,0131 \$
06.05.003	3,5x45	500/6000	AD	0,0328 \$

**SİVRİ UÇLU SIK DIŞLI ALÇIPAN VİDASI LGR**

KOD	ÜRÜN ADI	PAKET	BİRİM	FİYAT
06.06.001	3,5x25	1000/12000	AD	0,0079 \$
06.06.002	3,5x35	1000/8000	AD	0,01054 \$

**KAPALI KANCALI ÇELİK DÜBEL LGR**

KOD	ÜRÜN ADI	PAKET	BİRİM	FİYAT
06.13.001	M6	250	AD	0,24 \$
06.13.002	M8	100	AD	0,35 \$
06.13.003	M10	50	AD	0,60 \$

**AÇIK KANCALI ÇELİK DÜBEL LGR**

KOD	ÜRÜN ADI	PAKET	BİRİM	FİYAT
06.12.001	M6	250	AD	0,22 \$
06.12.002	M8	100	AD	0,33 \$
06.12.003	M10	50	AD	0,58 \$



### ÇAKMALI ÇELİK DÜBEL

LBR

KOD	ÜRÜN ADI	PAKET	BİRİM	FİYAT
06.11.004	M12	50	AD	

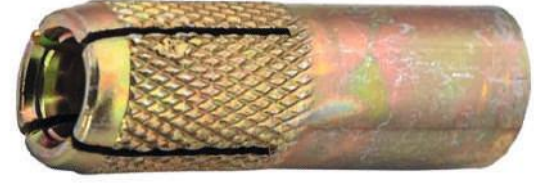

### GÖMLEKLİ ÇELİK DÜBEL

LBR

KOD	ÜRÜN ADI	KOLİ	BİRİM	FİYAT
06.09.001	6X45	500	AD	0,09 \$
06.09.002	6X65	400	AD	0,12 \$
06.09.003	8X55	300	AD	0,13 \$
06.09.004	8X75	200	AD	0,17 \$
06.09.005	8X100	150	AD	0,00 \$
06.09.006	10X70	150	AD	0,26 \$
06.09.007	10X85	100	AD	0,28 \$
06.09.009	12X90	50	AD	0,46 \$
06.09.010	12X110	50	AD	0,56 \$



### PLASTİK DÜBEL

KOD	ÜRÜN ADI	PAKET	BİRİM	FİYAT
06.15.001	6 mm	1000	AD	28,08 ₺
06.15.002	7 mm	1000	AD	28,35 ₺
06.15.003	8 mm	1000	AD	28,62 ₺
06.15.004	10 mm	500	AD	29,70 ₺
06.15.005	12 mm	500	AD	75,60 ₺
06.15.006	14 mm	250	AD	89,64 ₺

### PLASTİK PERFORMANS DÜBEL

KOD	ÜRÜN ADI	PAKET	BİRİM	FİYAT
06.16.001	8 mm	500	AD	39,96 ₺
06.16.002	10 mm	500	AD	59,40 ₺



### TUĞLA BOŞLUK DÜBELİ

KOD	ÜRÜN ADI	PAKET	BİRİM	FİYAT
06.18.001	8 mm	500	AD	39,96 ₺
06.18.002	10 mm	500	AD	49,68 ₺
06.18.003	12 mm	250	AD	81,00 ₺

### SİDİNG DÜBELİ

KOD	ÜRÜN ADI	PAKET	BİRİM	FİYAT
06.21.001	8x100	250	AD	35,10 ₺
06.21.002	10x100	100	AD	50,76 ₺
06.21.003	10x80	100	AD	46,44 ₺



### KANATLI ALÇIPAN DÜBELİ

KOD	ÜRÜN ADI	PAKET	BİRİM	FİYAT
06.19.001	2 mm	500	AD	91,80 ₺
06.19.002	3 mm	500	AD	97,20 ₺



### TURBOLET DÜBELİ (MATKAP UÇLU)

KOD	ÜRÜN ADI	PAKET	BİRİM	FİYAT
06.20.001	-	500	AD	75,60 ₺



### TURBOLET DÜBELİ (DÜZ UÇLU)

KOD	ÜRÜN ADI	PAKET	BİRİM	FİYAT
06.20.002	-	500	AD	73,44 ₺



### YAPRAK TURBOLET DÜBELİ (ÇELİK)

KOD	ÜRÜN ADI	PAKET	BİRİM	FİYAT
06.28.003	28 mm	500	AD	64,80 ₺



### GAZ BETON DÜBELİ

KOD	ÜRÜN ADI	PAKET	BİRİM	FİYAT
06.23.001	8 mm	100	AD	47,52 ₺
06.23.002	10 mm	100	AD	58,32 ₺



### KAPAKLI DÜBEL

KOD	ÜRÜN ADI	PAKET	BİRİM	FİYAT
06.28.003	10 mm	500	AD	81,00 ₺

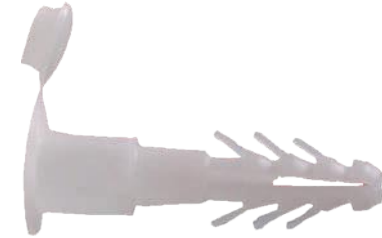

### ÇİVİLİ DÜBEL

KOD	ÜRÜN ADI	PAKET	BİRİM	FİYAT
06.25.001	7 mm	500	AD	49,68 ₺





### ÇELİK ÇİVİLİ KROŞE

KOD	ÜRÜN ADI	PAKET	BİRİM	FİYAT
06.20.003	NO:2	100	AD	4,70 ₺
06.20.004	NO:3	100	AD	6,48 ₺
06.20.005	NO:4	100	AD	6,48 ₺
06.20.006	NO:5	100	AD	9,18 ₺



### ÇİFTLİ YER TESPİT DÜBELİ

KOD	ÜRÜN ADI	PAKET	BİRİM	FİYAT
06.24.001	-	250	AD	32,40 ₺



### TEKLİ AYNA TIRNAĞI

KOD	ÜRÜN ADI	PAKET	BİRİM	FİYAT
06.15.007	15x20	500	AD	64,80 ₺



### PLASTİK VİDA PULU

KOD	ÜRÜN ADI	PAKET	BİRİM	FİYAT
06.26.001	-	1000	AD	23,22 ₺



### DOLAP ASKI ELEMANI

KOD	ÜRÜN ADI	PAKET	BİRİM	FİYAT
06.27.001	-	250	AD	0,70 ₺

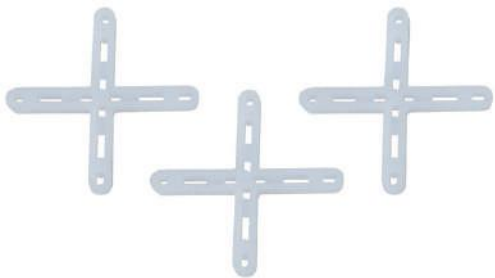

### DERZ ARTISI

KOD	ÜRÜN ADI	PAKET	BİRİM	FİYAT
07.01.099	2 mm DÜZ	500	AD	7,45 ₺
07.01.101	3 mm OLUKLU	500	AD	6,26 ₺
07.01.102	4 mm OLUKLU	500	AD	15,12 ₺



### ÇİROZ KOLU

KOD	ÜRÜN ADI	PAKET	BİRİM	FİYAT
04.30.001	-	12	AD	122,40 ₺



### HORTUM KELEPÇESİ

KOD	ÜRÜN ADI	KOLİ	BİRİM	FİYAT
06.29.001	8-13	50/1000	AD	0,65 ₺
06.29.002	10-16	50/1000	AD	0,65 ₺
06.29.003	13-19	50/1000	AD	0,65 ₺
06.29.004	16-23	50/1000	AD	0,65 ₺
06.29.005	18-25	50/1000	AD	0,70 ₺
06.29.006	19-26	50/1000	AD	1,30 ₺
06.29.007	20-30	50/1000	AD	1,40 ₺
06.29.008	22-36	50/1000	AD	1,51 ₺
06.29.009	25-42	50/500	AD	1,62 ₺
06.29.010	28-48	50/500	AD	1,67 ₺
06.29.011	32-51	50/500	AD	1,78 ₺
06.29.012	40-60	50/500	AD	0,00 ₺
06.29.013	44-64	50/500	AD	1,94 ₺
06.29.014	50-70	50/500	AD	2,00 ₺
06.29.015	57-76	50/500	AD	2,05 ₺
06.29.016	65-82	50/500	AD	₺ 2,27
06.29.017	76-92	50/150	AD	2,59 ₺
06.29.018	85-103	50/125	AD	2,92 ₺
06.29.019	92-110	50/125	AD	3,51 ₺
06.29.020	100-120	50/100	AD	3,94 ₺
06.29.021	110-130	50/75	AD	4,48 ₺
06.29.022	130-150	50/75	AD	4,75 ₺
06.29.023	146-164	50/75	AD	5,24 ₺

### İSKELE KELEPÇESİ

KOD	ÜRÜN ADI	KOLİ	BİRİM	FİYAT
06.38.001	DÜBELSİZ	24	AD	18,36 ₺



### CIRTLI PLASTİK KELEPÇE

KOD	ÜRÜN ADI	PAKET	BİRİM	FİYAT
06.30.012	2,5X150	100	AD	0,76 \$
06.30.001	3,6x150	100	AD	1,21 \$
06.30.002	3,6x200	100	AD	1,58 \$
06.30.003	3,6x250	100	AD	1,99 \$
06.30.004	3,6x300	100	AD	2,37 \$
06.30.005	3,6x370	100	AD	3,18 \$
06.30.006	4,8x200	100	AD	2,21 \$
06.30.007	4,8x250	100	AD	2,82 \$
06.30.008	4,8x300	100	AD	3,33 \$
06.30.009	4,8x350	100	AD	3,78 \$
06.30.011	4,8x400	100	AD	4,42 \$



### ÇİROZ

KOD	ÜRÜN ADI	PAKET	BİRİM	FİYAT
06.31.001	3 mm	500	AD	7,25 ₺
06.31.002	4 mm	500	AD	7,66 ₺





# SIVI ÇİVİ

## Poliüretanın Gücü



300kg  
10cm<sup>2</sup>



- GÜÇLÜ
- DAYANIKLI
- GÜVENİLİR

Profesyonellerin tercihi

**12 dk.'da montaj imkanı**

\*12 dakika kuruma süresi 23°C ve %50 bağıl nemde yapılan montaj için geçerlidir. Sıcaklık ve nem oranının farklı değerlerde olması montaj süresini değiştirebilir.





# NALBURIYE ÜRÜNLER





### YAPARLAR EL ARABASI

KOD	ÜRÜN ADI	PAKET	BİRİM	FİYAT
07.07.005	PRO TÜP BURÇ	1	AD	439,24 ₺
07.07.006	YKS 80 TÜP BURÇLU	1	AD	342,71 ₺
07.07.007	FÜZE 70 TÜP BURÇLU	1	AD	173,51 ₺

### EL ARABASI TEKERİ

KOD	ÜRÜN ADI	PAKET	BİRİM	FİYAT
07.01.033	DOLGU	5	AD	22,16 ₺
07.01.034	ŞİŞME	5	AD	9,37 \$

### KÜREK

KOD	ÜRÜN ADI	PAKET	BİRİM	FİYAT
07.01.005	BEL KÜREĞİ	25	AD	33,20 ₺
07.07.002	İNŞAAT KÜREK	25	AD	27,76 ₺

### FARYAP KÜREĞİ

KOD	ÜRÜN ADI	PAKET	BİRİM	FİYAT
17000	4300 SAPSIZ	5	AD	42,96 ₺
17050	4301 SAPLI	5	AD	95,10 ₺
17100	6300 SAPSIZ	5	AD	46,71 ₺
17150	6301 SAPLI	5	AD	97,17 ₺

### ÇÖP KÜREĞİ

KOD	ÜRÜN ADI	PAKET	BİRİM	FİYAT
29010	-	5	AD	18,00 ₺



**KAZMA**

KOD	ÜRÜN ADI	PAKET	BİRİM	FİYAT
07.01.001	İTHAL	6	AD	55,40 ₺

**ÜÇGEN ÇAPA**

KOD	ÜRÜN ADI	PAKET	BİRİM	FİYAT
07.01.013	İTHAL	12	AD	29,83 ₺

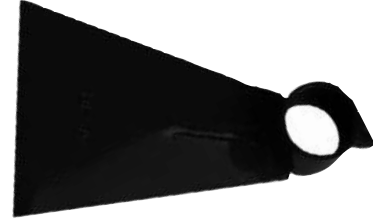
**BURGULU TIRMIK**

KOD	ÜRÜN ADI	PAKET	BİRİM	FİYAT
07.01.006	12 DİŞ	6	AD	13,68 ₺
07.01.007	14 DİŞ	6	AD	14,36 ₺
07.01.008	16 DİŞ	6	AD	15,05 ₺
07.01.009	18 DİŞ	6	AD	15,94 ₺
07.01.010	20 DİŞ	6	AD	16,62 ₺

**ÇATALLI ÇAPA**

KOD	ÜRÜN ADI	PAKET	BİRİM	FİYAT
07.01.011	ÇAPA	12	AD	29,83 ₺

**BALTA / NACAK**

KOD	ÜRÜN ADI	PAKET	BİRİM	FİYAT
07.01.002	BALTA	10	AD	78,50 ₺
07.01.003	NACAK	10	AD	42,85 ₺







### ACR 120 EL ARABASI

KOD	ÜRÜN ADI	KOLİ	BİRİM	FİYAT
ACR1011	TÜP BURÇLU	1	AD	321,32 ₺
ACR1012	TÜP RULMANLI	1	AD	340,00 ₺
ACR1013	ŞİŞME RULMANLI	1	AD	360,00 ₺
ACR1014	ŞİŞME PLS.JANTLI	1	AD	362,96 ₺

Tekne Kalınlığı 1.20 mm dir.  
Şasi 32x2.00 mm olup Saç Ayaklıdır.  
Tekne Hacmi Sıvı: 85 Lt / Kum: 100 Lt'dir.  
Yeşil Renkte olup,Fırın Boyalıdır.



### ACR 80 EL ARABASI

KOD	ÜRÜN ADI	KOLİ	BİRİM	FİYAT
ACR1006	TÜP BURÇLU	1	AD	259,79 ₺
ACR1007	TÜP RULMANLI	1	AD	277,80 ₺
ACR1008	ŞİŞME RULMANLI	1	AD	297,70 ₺
ACR1009	ŞİŞME PLS.JANTLI	1	AD	301,43 ₺

Tekne Kalınlığı 0.80 mm dir.  
Şasi 32x1.50 mm olup Boru Ayaklıdır.  
Tekne Hacmi Sıvı: 85 Lt / Kum: 100 Lt'dir.  
Yeşil Renkte olup,Fırın Boyalıdır.



### ACR 70 EL ARABASI

KOD	ÜRÜN ADI	KOLİ	BİRİM	FİYAT
ACR1001	TÜP BURÇLU	1	AD	189,56 ₺
ACR1002	TÜP RULMANLI	1	AD	207,58 ₺
ACR1003	ŞİŞME RULMANLI	1	AD	227,50 ₺
ACR1004	ŞİŞME PLS.JANTLI	1	AD	231,20 ₺

Tekne Kalınlığı 0.70 mm dir.  
Şasi 32x1.20 mm olup Boru Ayaklıdır.  
Tekne Hacmi Sıvı: 85 Lt / Kum: 100 Lt'dir.  
Turkuaz Renkte olup,Fırın Boyalıdır.



### GALVANİZLİ EL ARABASI

KOD	ÜRÜN ADI	KOLİ	BİRİM	FİYAT
ACR370	TÜP BURÇLU	1	AD	205,72 ₺
ACR371	TÜP RULMANLI	1	AD	222,81 ₺
ACR372	ŞİŞME RULMANLI	1	AD	242,40 ₺
ACR373	ŞİŞME PLS.JANTLI	1	AD	246,11 ₺

Tekne Kalınlığı 1.00 mm dir.  
Şasi 32x1.50 mm olup Boru Ayaklıdır.  
Tekne Hacmi Sıvı: 85 Lt / Kum: 100 Lt'dir.  
Galvaniz kaplamadır.



### ACR ŞİŞME TEKER

KOD	ÜRÜN ADI	KOLİ	BİRİM	FİYAT
ACR363	GALVANİZ JANT 350x7	5	AD	9,95 \$



### ACR ŞİŞME TEKER

KOD	ÜRÜN ADI	KOLİ	BİRİM	FİYAT
ACR362	BOYALI SAC JANT 350x7	5	AD	8,50 \$



### ACR ŞİŞME TEKER

KOD	ÜRÜN ADI	KOLİ	BİRİM	FİYAT
ACR365	PLASTİK JANT 350x7	5	AD	9,14 \$

### TÜP TEKER

KOD	ÜRÜN ADI	KOLİ	BİRİM	FİYAT
ACR366	BURÇLU 350x7	5	AD	20,14 ₺
ACR367	RULMANLI 350x7	5	AD	29,40 ₺



### KÜREK

KOD	ÜRÜN ADI	KOLİ	BİRİM	FİYAT
ACR483	NO:4	25	AD	10,94 ₺
ACR382	SİVRİ	25	AD	12,74 ₺

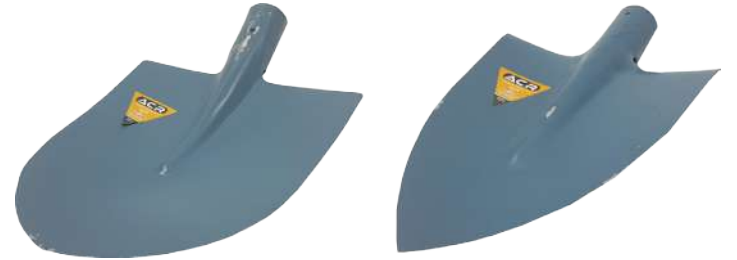

### ACR İÇ LASTİK

KOD	ÜRÜN ADI	KOLİ	BİRİM	FİYAT
ACR365	350x7	5	AD	1,64 \$







### DÜZ BALYOZ

KOD	ÜRÜN ADI	PAKET	BİRİM	FİYAT
07.01.014	3 kg	5	AD	50,27 ₺
07.01.103	4 kg	5	AD	67,58 ₺
07.01.104	5 kg	5	AD	83,79 ₺
07.01.105	8 kg	5	AD	134,06 ₺



### METAL UZATMALI SIRIK

KOD	ÜRÜN ADI	PAKET	BİRİM	FİYAT
08.04.045	2 mt	10	AD	19,32 ₺
08.04.046	3 mt	10	AD	22,08 ₺
08.04.047	4 mt	10	AD	28,70 ₺
08.04.048	6 mt	10	AD	77,28 ₺

### SAPLAR



KOD	ÜRÜN ADI	PAKET	BİRİM	FİYAT
07.01.020	FIRÇA SAPI 1,20 mt	30	AD	6,29 ₺
07.01.021	FIRÇA SAPI 1,50 mt	30	AD	7,66 ₺
07.01.022	FIRÇA SAPI 2,00 mt	30	AD	9,58 ₺
07.01.016	KÜREK SAPI TORNALI	10	AD	16,89 ₺
07.01.017	BALTA SAPI	10	AD	14,23 ₺
07.01.018	NACAK SAPI	10	AD	9,71 ₺
07.01.019	BALYOZ SAPI	10	AD	12,93 ₺
07.01.031	KAZMA SAPI	10	AD	12,45 ₺

### ÇEKİÇ SAPI

KOD	ÜRÜN ADI	PAKET	BİRİM	FİYAT
07.01.023	200 gr	10	AD	3,90 ₺
07.01.024	300 gr	10	AD	4,79 ₺
07.01.025	500 gr	10	AD	5,61 ₺
07.01.026	1000 gr	10	AD	7,66 ₺
07.01.027	1500 gr	10	AD	9,23 ₺
07.01.028	2000 gr	10	AD	9,99 ₺



### KESER SAPI

KOD	ÜRÜN ADI	PAKET	BİRİM	FİYAT
07.01.030	1. KALİTE	50	AD	7,25 ₺
07.01.029	EKO	50	AD	4,51 ₺



### NAYLON BRANDA

KOD	ÜRÜN ADI	PAKET	BİRİM	FİYAT
07.01.072	1.KALİTE 2-4 mt	-	KG	



### NAYLON BRANDA

KOD	ÜRÜN ADI	PAKET	BİRİM	FİYAT
07.01.073	2.KALİTE 2-4 mt	-	KG	17,10 ₺



### BALONCUKLU NAYLON

KOD	ÜRÜN ADI	PAKET	BİRİM	FİYAT
07.01.282	100 CM	-	MT <sup>2</sup>	0,37 \$
07.01.256	120 CM	-	MT <sup>2</sup>	0,37 \$
07.01.283	150 CM	-	MT <sup>2</sup>	0,37 \$



### SIVA FİLESİ

KOD	ÜRÜN ADI	PAKET	BİRİM	FİYAT
07.01.150	165 gr TURUNCU	50/200	AD	0,44 \$
07.01.151	165 gr MAVİ	50/200	AD	0,44 \$



### ÇUVAL

KOD	ÜRÜN ADI	PAKET	BİRİM	FİYAT
07.01.085	60X90		AD	1,63 ₺
07.01.092	48X78		AD	1,01 ₺
07.01.336	MOLOZ		AD	1,01 ₺

### SIVA SÜNGERİ

KOD	ÜRÜN ADI	PAKET	BİRİM	FİYAT
07.01.045	RENKLİ	24	AD	52,80 ₺
07.01.046	BEYAZ	24	AD	40,80 ₺

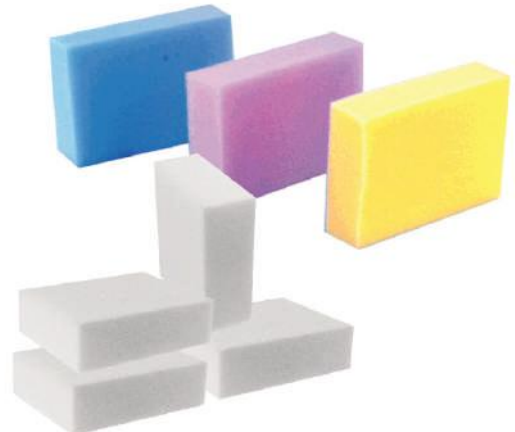



### LOW PVC PUNTALI TEL 0.80 mm

KOD	ÜRÜN ADI	PAKET	BİRİM	FİYAT
ACR057	12X12 100cm	25	MT	1,29 \$
ACR058	12X12 120 cm	25	MT	1,59 \$
ACR059	12X12 150 cm	25	MT	2,39 \$

### ACR PVC PUNTALI TEL 1.00 mm

KOD	ÜRÜN ADI	PAKET	BİRİM	FİYAT
ACR050	12X12 100cm	25	M <sup>2</sup>	1,77 \$
ACR051	12X12 120 cm	30	M <sup>2</sup>	1,77 \$
ACR052	12X12 150 cm	37,5	M <sup>2</sup>	1,77 \$



### ACR PVC PUNTALI TEL 2.00 mm

KOD	ÜRÜN ADI	PAKET	BİRİM	FİYAT
ACR050	25X25 100cm	25	M <sup>2</sup>	2,94 \$
ACR051	25X25 120 cm	30	M <sup>2</sup>	2,94 \$
ACR052	25X25 150 cm	37,5	M <sup>2</sup>	2,94 \$

### ACR PVC PUNTALI TEL 2.05 mm

KOD	ÜRÜN ADI	PAKET	BİRİM	FİYAT
ACR050	50X50 100cm	25	M <sup>2</sup>	3,00 \$
ACR051	50X50 120 cm	30	M <sup>2</sup>	3,00 \$
ACR052	50X50 150 cm	37,5	M <sup>2</sup>	3,00 \$
ACR051	50X50 200 cm	50	M <sup>2</sup>	3,00 \$



### ACR GALVANİZ KÜMES TELİ

KOD	ÜRÜN ADI	PAKET	BİRİM	FİYAT
ACR115	1/2 100cm	20	MT <sup>2</sup>	0,92 \$
ACR116	1/2 120 cm	24	MT <sup>2</sup>	0,92 \$
ACR117	1/2 150 cm	30	MT <sup>2</sup>	0,92 \$

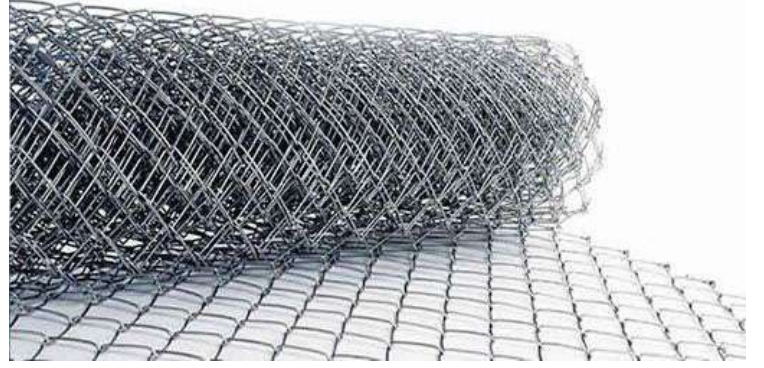

### ACR PVC KAPLI KÜMES TELİ

KOD	ÜRÜN ADI	PAKET	BİRİM	FİYAT
ACR110	1/2 100cm	20	MT <sup>2</sup>	1,45 \$
ACR111	1/2 120 cm	24	MT <sup>2</sup>	1,45 \$
ACR112	1/2 150 cm	30	MT <sup>2</sup>	1,45 \$



### ACR RABİS TELİ

KOD	ÜRÜN ADI	PAKET	BİRİM	FİYAT
ACR745	RULO	50	MT	0,53 \$

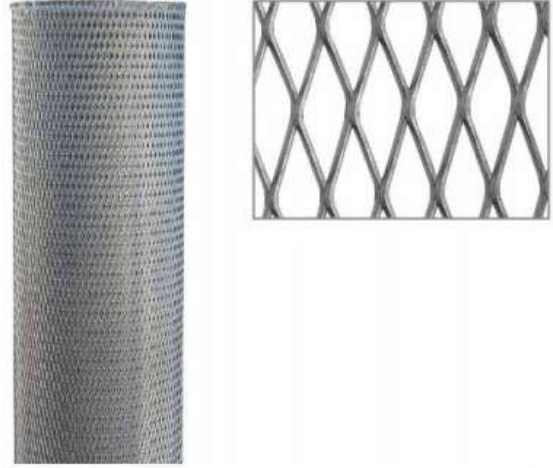

### İNŞAAT MAKARASI

KOD	ÜRÜN ADI	KOLİ	BİRİM	FİYAT
ACR630	25X25 100cm	5	AD	40,92 ₺
ACR632	25X25 120 cm	5	AD	46,86 ₺







### PLASTİK MENFEZ

KOD	ÜRÜN ADI	PAKET	BİRİM	FİYAT
07.19.024	25X45	1	AD	26,46 ₺
07.19.017	30X30	1	AD	24,84 ₺
07.19.018	35X35	1	AD	29,16 ₺
07.19.019	35X45	1	AD	33,48 ₺
07.19.025	35X55	1	AD	39,15 ₺
07.19.020	40X40	1	AD	34,02 ₺
07.19.029	40X50	1	AD	39,96 ₺
07.19.021	45X45	1	AD	38,88 ₺
07.19.022	45X55	1	AD	42,12 ₺
07.19.026	45X65	1	AD	46,98 ₺
07.19.016	50X50	1	AD	44,82 ₺
07.19.001	55X55	1	AD	49,95 ₺
07.19.023	55X65	1	AD	54,54 ₺
07.19.027	60X60	1	AD	56,70 ₺
07.19.028	65X65	1	AD	61,56 ₺

### CAM MENFEZ

KOD	ÜRÜN ADI	PAKET	BİRİM	FİYAT
07.11.001	YUVARLAK	100	AD	3,78

### USTA KALEMİ

KOD	ÜRÜN ADI	PAKET	BİRİM	FİYAT
04.23.011	KIRMIZI	12/2400	AD	2,78 ₺
04.23.012	SİYAH	12/2400	AD	2,78 ₺

### TESTERE KOLU

KOD	ÜRÜN ADI	PAKET	BİRİM	FİYAT
07.01.142	PLASTİK	36	AD	15,46 \$

### TESTERE KOLU

KOD	ÜRÜN ADI	PAKET	BİRİM	FİYAT
07.01.141	LAMA	36	AD	31,46 \$

### PİMAPEN KOLU

KOD	ÜRÜN ADI	KOLİ	BİRİM	FİYAT
	BEYAZ	48	AD	5,81 ₺



### İSKOTA HALAT

KOD	ÜRÜN ADI	PAKET	BİRİM	FİYAT
07.01.057	5 MM	-	KG	23,46 ₺
07.01.058	6 MM	-	KG	23,46 ₺
07.01.059	8 MM	-	KG	20,86 ₺
07.01.060	10 MM	-	KG	20,86 ₺
07.01.061	12 MM	-	KG	20,86 ₺



### NAYLON HALAT

KOD	ÜRÜN ADI	PAKET	BİRİM	FİYAT
07.01.058	4 MM	-	KG	36,46 ₺
07.01.047	5 MM	-	KG	36,46 ₺
07.01.048	6 MM	-	KG	36,46 ₺
07.01.049	8 MM	-	KG	36,46 ₺
07.01.050	10 MM	-	KG	36,46 ₺
07.01.051	12 MM	-	KG	36,46 ₺



### KENDİR HALAT

KOD	ÜRÜN ADI	PAKET	BİRİM	FİYAT
07.01.052	5 MM	-	KG	29,41 ₺
07.01.053	6 MM	-	KG	29,41 ₺
07.01.054	8 MM	-	KG	28,04 ₺
07.01.055	10 MM	-	KG	28,04 ₺
07.01.056	12 MM	-	KG	28,04 ₺



### ÇAMAŞIR İPİ

KOD	ÜRÜN ADI	KOLİ	BİRİM	FİYAT
07.01.062	-	48	AD	1,55 ₺





### BOYALI ÇIRPI İPİ

KOD	ÜRÜN ADI	PAKET	BİRİM	FİYAT
07.01.069	-	25	AD	19,65 ₺

### ÇIRPI İPİ

KOD	ÜRÜN ADI	PAKET	BİRİM	FİYAT
07.01.065	70 gr	24	AD	2,44 ₺
07.01.066	100 gr	12	AD	3,96 ₺
07.01.067	200 gr	12	AD	6,27 ₺
07.01.068	400 gr	12	AD	13,20 ₺

### AMBALAJ İPİ

KOD	ÜRÜN ADI	PAKET	BİRİM	FİYAT
07.01.063	-	-	AD	35,09 ₺

### PROFİL MERDİVEN

KOD	ÜRÜN ADI	PAKET	BİRİM	FİYAT
07.01.035	3+1 BASAMAK	1	AD	113,13 ₺
07.01.036	4+1 BASAMAK	1	AD	134,68 ₺
07.01.037	5+1 BASAMAK	1	AD	158,00 ₺
07.01.038	6+1 BASAMAK	1	AD	183,18 ₺
07.01.039	7+1 BASAMAK	1	AD	226,40 ₺
07.01.040	8+1 BASAMAK	1	AD	258,07 ₺
07.01.041	9+1 BASAMAK	1	AD	300,82 ₺

### ÇİFT ÇIKIŞLI ALÜMİNYUM MERDİVEN

KOD	ÜRÜN ADI	PAKET	BİRİM	FİYAT
MV103	3 BASAMAK	1	AD	192,89 ₺
MV104	4 BASAMAK	1	AD	247,61 ₺
MV105	5 BASAMAK	1	AD	302,33 ₺
MV106	6 BASAMAK	1	AD	344,74 ₺
MV107	7 BASAMAK	1	AD	410,40 ₺
MV108	8 BASAMAK	1	AD	467,86 ₺
MV109	9 BASAMAK	1	AD	519,84 ₺



### AKROBAT MERDİVEN

KOD	ÜRÜN ADI	PAKET	BİRİM	FİYAT
MV201	3700 mm 4x3	1	AD	725,04 ₺
MV202	4700 mm 4x4	1	AD	779,76 ₺



### ALÜMİNYUM SÜRGÜLÜ MERDİVENLER (PTT)

KOD	ÜRÜN ADI	PAKET	BİRİM	FİYAT
MV300	2x2 4 mt	1	AD	410,40 ₺
MV301	2x2,5 5 mt	1	AD	513,00 ₺
MV302	2x3 6 mt	1	AD	615,60 ₺
MV303	2x4 8 mt	1	AD	820,80 ₺
MV304	2x5 10 mt	1	AD	1.026,00 ₺
MV305	2x6 12 mt	1	AD	1.231,20 ₺
MV310	Tekli 4 mt	1	AD	410,40 ₺
MV311	Tekli 5 mt	1	AD	513,00 ₺







### PÜR MÜZ

KOD	ÜRÜN ADI	KOLİ	BİRİM	FİYAT
04.23.006	AYGAZ	40	AD	42,38 \$
04.23.007	İPRAGAZ	40	AD	55,27 \$

### TETİKLİ ŞALİMO

KOD	ÜRÜN ADI	KOLİ	BİRİM	FİYAT
07.10.001	33 cm	12	AD	177,84 ₺
07.10.002	55 cm	12	AD	336,00 ₺

### KAPI İTME YAYI

KOD	ÜRÜN ADI	PAKET	BİRİM	FİYAT
05.31.004	-	12	AD	42,24 ₺

### KAPI YAYI

KOD	ÜRÜN ADI	PAKET	BİRİM	FİYAT
05.31.014	3/8	1	DZ	43,56 ₺
05.31.015	1/2	1	DZ	43,56 ₺
05.31.016	5/8	1	DZ	43,56 ₺

### EMNİYET KELEPÇESİ

KOD	ÜRÜN ADI	PAKET	BİRİM	FİYAT
	SARI	20	AD	17,16 ₺
	KROM	20	AD	17,16 ₺
	SATEN	20	AD	17,16 ₺

### EMNİYET ZİNCİRİ

KOD	ÜRÜN ADI	PAKET	BİRİM	FİYAT
05.30.002	SARI	25	AD	15,84 ₺
	KROM	25	AD	15,84 ₺
05.30.003	SATEN	25	AD	15,84 ₺

### ÇALI FIRÇA PLASTİK

KOD	ÜRÜN ADI	PAKET	BİRİM	FİYAT
07.01.080	30 cm	36	AD	11,92 ₺
07.01.081	40 cm	36	AD	13,03 ₺
07.01.082	50 cm	24	AD	18,55 ₺
07.01.083	60 cm	12	AD	21,53 ₺



### OTO FIRÇA

KOD	ÜRÜN ADI	PAKET	BİRİM	FİYAT
07.01.077	17 cm	36	AD	6,45 ₺
07.01.078	20 cm	36	AD	9,29 ₺
07.01.079	20 cm BATTAL	36	AD	8,05 ₺



### HALI YIKAMA YER FIRÇASI

KOD	ÜRÜN ADI	PAKET	BİRİM	FİYAT
08.04.036	SERT		AD	7,90 ₺



### CAM SİL

KOD	ÜRÜN ADI	PAKET	BİRİM	FİYAT
08.04.038	KÜÇÜK	50	AD	10,49 ₺
08.04.037	BÜYÜK	50	AD	6,62 ₺



### PLASTİK YERSİL

KOD	ÜRÜN ADI	PAKET	BİRİM	FİYAT
08.04.039	40 cm	50	AD	6,62 ₺
08.04.040	50 cm	50	AD	8,28 ₺



### METAL YERSİL

KOD	ÜRÜN ADI	PAKET	BİRİM	FİYAT
08.04.041	40 cm	12	AD	19,87 ₺
08.04.042	50 cm	12	AD	21,53 ₺
08.04.043	75 cm	12	AD	24,07 ₺





### ALÜMİNYUM KÜPEŞTE ASKILIK

KOD	ÜRÜN ADI	KOLİ	BİRİM	FİYAT
07.01.076	BLİSTER	24	AD	54,00 ₺



### SABİT ÇAMAŞIR ASKILIK

KOD	ÜRÜN ADI	KOLİ	BİRİM	FİYAT
07.01.074	BLİSTER	24	AD	54,00 ₺



### KATLANIR ÇAMAŞIR ASKILIK

KOD	ÜRÜN ADI	KOLİ	BİRİM	FİYAT
07.01.075	BLİSTER	24	AD	54,00



### LAVABO KANAL AÇMA TELİ

KOD	ÜRÜN ADI	PAKET	BİRİM	FİYAT
07.01.088	3 mt	60	AD	25,99 ₺
07.01.089	5 mt	60	AD	34,20 ₺
07.01.090	8 mt	60	AD	46,51 ₺

### KANAL AÇMA TELİ

KOD	ÜRÜN ADI	PAKET	BİRİM	FİYAT
07.01.093	3 mt	60	AD	46,51 ₺
07.01.094	5 mt	48	AD	74,56 ₺
07.01.095	10 mt	36	AD	142,27 ₺
07.01.096	15 mt	24	AD	213,41 ₺

### İNŞAAT TELİ

KOD	ÜRÜN ADI	KOLİ	BİRİM	FİYAT
01.07.176	-	-	AD	



### KANALLI ÇELİK ÇİVİ BEYAZ

KOD	ÜRÜN ADI	PAKET	BİRİM	FİYAT
07.01.157	4x40	100	AD	5,69 ₺
07.01.158	4x50	100	AD	6,50 ₺
07.01.159	4x60	100	AD	7,32 ₺
07.01.160	5x80	100	AD	14,23 ₺
07.01.161	5x100	100	AD	17,50 ₺



### CAM ÇİVİSİ

KOD	ÜRÜN ADI	PAKET	BİRİM	FİYAT
07.01.162	5x22	1 (2,5kg)	PK	40,68 ₺



### PLASTİK ŞAPKALI ÇATI ÇİVİSİ

KOD	ÜRÜN ADI	PAKET	BİRİM	FİYAT
07.01.165	8 cm	400	AD	4,03 \$
07.01.166	10 cm	400	AD	4,56 \$

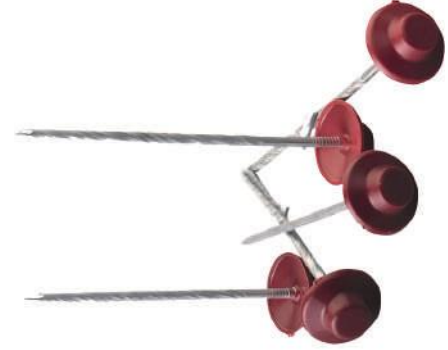

### ŞİNGİL ÇİVİSİ

KOD	ÜRÜN ADI	PAKET	BİRİM	FİYAT
07.01.334	2,0 cm	-	AD	40,68 ₺
07.01.332	2,5 cm	-	AD	40,68 ₺
07.01.333	3,0 cm	-	AD	40,68 ₺



### SARI TEL ÇİVİ

KOD	ÜRÜN ADI	PAKET	BİRİM	FİYAT
07.01.167	3 TP	2,5 kg	AD	41,69 ₺
07.01.168	4 TP	2,5 kg	AD	41,69 ₺
07.01.169	5 TP	2,5 kg	AD	41,69 ₺
07.01.170	3 TH	2,5 kg	AD	41,69 ₺
07.01.171	4 TH	2,5 kg	AD	41,69 ₺
07.01.172	5 TH	2,5 kg	AD	41,69 ₺





**ÇİVİ ÖNLÜĞÜ**

KOD	ÜRÜN ADI	KOLİ	BİRİM	FİYAT
07.01.098	DERİ	60	AD	34,20 ₺

**ÇİVİ ÖNLÜĞÜ**

KOD	ÜRÜN ADI	KOLİ	BİRİM	FİYAT
07.01.097	BRANDA	60	AD	15,73 ₺

**ÇELİK ÇİVİ SARI**

KOD	ÜRÜN ADI	PAKET	BİRİM	FİYAT
01.07.155	2x30	100'lü	AD	1,87 ₺
01.07.156	3x30	100'lü	AD	4,90 ₺

**İNŞAAT ÇİVİ**

KOD	ÜRÜN ADI	PAKET	BİRİM	FİYAT
07.01.177	6	25	KG	
07.01.178	8	25	KG	
07.01.179	10	25	KG	
07.01.180	12	25	KG	
07.01.181	15	25	KG	

### NORM TİPİ PASPAY

KOD	ÜRÜN ADI	KOLİ	BİRİM	FİYAT
N0001	20 mm / 8-24 mm	1500	AD	0,17 ₺
N0002	25 mm / 8-24 mm	1000	AD	0,14 ₺
N0003	30 mm / 8-24 mm	1000	AD	0,23 ₺
N0004	40 mm / 8-24 mm	1000	AD	0,28 ₺
N0005	50 mm / 8-24 mm	500	AD	0,28 ₺
N0006	50 mm / 20-32 mm	250	AD	1,14 ₺



### PERDE KOLON TİPİ PASPAY

KOD	ÜRÜN ADI	KOLİ	BİRİM	FİYAT
N0010	20 mm / 6-12 mm	2500	AD	0,09 ₺
N0011	25 mm / 6-14 mm	2000	AD	0,08 ₺
N0003	30 mm / 8-12 mm	1000	AD	0,18 ₺
N0014	40 mm / 12-16 mm	1000	AD	0,28 ₺
N0015	50 mm / 8-16 mm	500	AD	0,50 ₺
N0016	50 mm / 8-32 mm	500	AD	1,29 ₺

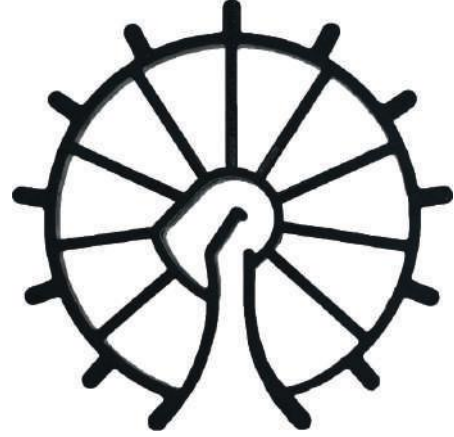

### MANDAL TİPİ PASPAY

KOD	ÜRÜN ADI	KOLİ	BİRİM	FİYAT
N0020	20 mm / 6-14 mm	2500	AD	0,12 ₺
N0021	25 mm / 6-14 mm	2500	AD	0,12 ₺
N0022	30 mm / 6-14 mm	2000	AD	0,12 ₺



### DÖŞEME PERDE TİPİ PASPAY

KOD	ÜRÜN ADI	KOLİ	BİRİM	FİYAT
N0030	25 mm / 6-18 mm	2000	AD	0,20 ₺
N0031	30 mm / 6-18 mm	2000	AD	0,30 ₺



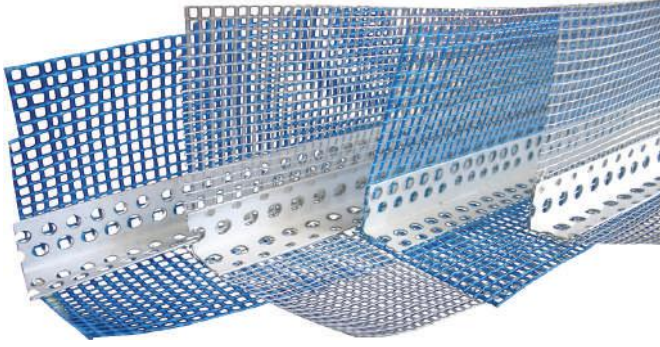

### FİLELİ KÖŞE PROFİLİ

KOD	ÜRÜN ADI	KOLİ	BİRİM	FİYAT
07.01.210	7x7 - 2.50 MT	100	AD	4,86 ₺



### ALÇI KÖŞE PROFİLİ

KOD	ÜRÜN ADI	KOLİ	BİRİM	FİYAT
06.28.006	METAL 2.70 mt	50	AD	0,53 \$

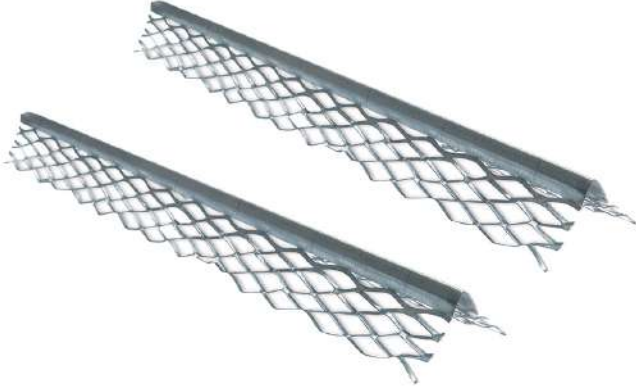

### METAL KABA SIVA KÖŞE PROFİLİ

KOD	ÜRÜN ADI	KOLİ	BİRİM	FİYAT
06.28.005	2.70 mt	100	AD	0,60 \$



### STRAFÖR DÜBELİ

KOD	ÜRÜN ADI	ÇUVAL	BİRİM	FİYAT
06.28.001	100	400	AD	88,56 ₺
06.28.002	120	500	AD	108,00 ₺

**SİLİKON TABANCASI PROFESYONEL**

KOD	ÜRÜN ADI	KOLİ	BİRİM	FİYAT
07.01.143	ALÜMÜNYUM DÖKÜM	24	AD	5,90 \$

**SİLİKON TABANCASI**

KOD	ÜRÜN ADI	KOLİ	BİRİM	FİYAT
07.01.145	PLASTİK	40	AD	2,60 \$

**EPOKSİ TABANCASI**

KOD	ÜRÜN ADI	KOLİ	BİRİM	FİYAT
07.01.146	345 ml	24	AD	6,41 \$

**EPOKSİ TABANCASI**

KOD	ÜRÜN ADI	KOLİ	BİRİM	FİYAT
07.01.254	410 ml	24	AD	13,68 \$

**SOSİS TABANCASI 600 ml**

KOD	ÜRÜN ADI	KOLİ	BİRİM	FİYAT
07.01.148	ALÜMİNYUM	24	AD	12,67 \$







### SABİT SERVİS TEKERİ

KOD	ÜRÜN ADI	KOLİ	BİRİM	FİYAT
	80 mm / 80 kg	30	AD	20,38 ₺
	100 mm / 70 kg	30	AD	27,15 ₺
	125 mm / 100 kg	20	AD	32,49 ₺
	150 mm / 125 kg	10	AD	41,66 ₺
	200 mm / 170 kg	8	AD	65,39 ₺

### DÖNER SERVİS TEKERİ

KOD	ÜRÜN ADI	KOLİ	BİRİM	FİYAT
	80 mm / 80 kg	30	AD	30,16 ₺
	100 mm / 70 kg	30	AD	38,17 ₺
	125 mm / 100 kg	20	AD	43,30 ₺
	150 mm / 125 kg	10	AD	50,89 ₺
	200 mm / 170 kg	8	AD	82,70 ₺



### FRENLİ DÖNER SERVİS TEKERİ

KOD	ÜRÜN ADI	KOLİ	BİRİM	FİYAT
	80 mm / 80 kg	30	AD	36,94 ₺
	100 mm / 70 kg	30	AD	48,36 ₺
	125 mm / 100 kg	20	AD	53,49 ₺
	150 mm / 125 kg	10	AD	59,85 ₺
	200 mm / 170 kg	8	AD	92,89 ₺



### GRİ SABİT TEKER

KOD	ÜRÜN ADI	KOLİ	BİRİM	FİYAT
	50 mm / 50 kg	140	AD	6,09 ₺
	75 mm / 70 kg	60	AD	11,97 ₺
	100 mm / 80 kg	30	AD	19,08 ₺
	125 mm / 100 kg	20	AD	24,21 ₺



### GRİ DÖNER TEKER

KOD	ÜRÜN ADI	KOLİ	BİRİM	FİYAT
	50 mm / 50 kg	140	AD	10,19 ₺
	75 mm / 70 kg	60	AD	15,94 ₺
	100 mm / 80 kg	30	AD	34,41 ₺
	125 mm / 100 kg	20	AD	38,17 ₺

### GRİ FRENLİ DÖNER TEKER

KOD	ÜRÜN ADI	KOLİ	BİRİM	FİYAT
	50 mm / 50 kg	120	AD	13,68 ₺
	75 mm / 70 kg	60	AD	19,08 ₺
	100 mm / 80 kg	30	AD	39,47 ₺
	125 mm / 100 kg	20	AD	43,30 ₺



### POLİPROPİLEN SABİT BURÇLU TEKER

KOD	ÜRÜN ADI	KOLİ	BİRİM	FİYAT
	80 mm / 65 kg	30	AD	19,08 ₺
	100 mm / 80 kg	30	AD	27,09 ₺
	125 mm / 120 kg	20	AD	33,11 ₺
	150 mm / 170 kg	10	AD	40,77 ₺
	200 mm / 250 kg	8	AD	66,21 ₺



### POLİPROPİLEN DÖNER BURÇLU TEKER

KOD	ÜRÜN ADI	KOLİ	BİRİM	FİYAT
	80 mm / 65 kg	30	AD	30,57 ₺
	100 mm / 80 kg	30	AD	36,94 ₺
	125 mm / 120 kg	20	AD	43,30 ₺
	150 mm / 170 kg	10	AD	53,49 ₺
	200 mm / 250 kg	8	AD	89,06 ₺



### POLİPROPİLEN FRENLİ BURÇLU TEKER

KOD	ÜRÜN ADI	KOLİ	BİRİM	FİYAT
	80 mm / 65 kg	30	AD	35,64 ₺
	100 mm / 80 kg	30	AD	48,36 ₺
	125 mm / 120 kg	20	AD	53,49 ₺
	150 mm / 170 kg	10	AD	66,21 ₺
	200 mm / 250 kg	8	AD	99,25 ₺





### FARE KAPANI

KOD	ÜRÜN ADI	KOLİ	BİRİM	FİYAT
	METAL	40	DZ	38,65 ₺



### POSTA KUTUSU

KOD	ÜRÜN ADI	PAKET	BİRİM	FİYAT
07.01.152	METAL	25	AD	36,94 \$
07.01.177	PLASTİK	25	AD	34,20 ₺



### BACA KAPAĞI

KOD	ÜRÜN ADI	KOLİ	BİRİM	FİYAT
07.01.230	190 mm Dönerli	50	AD	6,00 ₺
07.01.247	16x16 Panjur Tip	50	AD	7,02 ₺





### CAM MACUNU

KOD	ÜRÜN ADI	KOLİ	BİRİM	FİYAT
	POŞETLİ 1 KG	10	AD	



### ELEKTROD

KOD	ÜRÜN ADI	PAKET	BİRİM	FİYAT
04.10.012	2,5x350	6	PK	
04.10.013	3,25x350	4	PK	



# İNŞAAT VE DEKORASYON







### EXPORT RULO

KOD	ÜRÜN ADI	KOLİ	BİRİM	FİYAT
1080	20 cm	25	AD	27,16 ₺
1081	25 cm	25	AD	29,78 ₺
1096	20 cm Yedek	25	AD	21,64 ₺
1097	25 cm Yedek	25	AD	23,99 ₺

### EXPORT KALORİFER RULO

KOD	ÜRÜN ADI	KOLİ	BİRİM	FİYAT
1084	10 cm	50	AD	6,20 ₺

### EXPORT KALORİFER RULO YEDEK

KOD	ÜRÜN ADI	KOLİ	BİRİM	FİYAT
2100	10 cm	12 PAKET	AD	45,49 ₺

### PLASDEK RULO

KOD	ÜRÜN ADI	KOLİ	BİRİM	FİYAT
1015	20 cm	25	AD	27,16 ₺
1017	25 cm	25	AD	29,78 ₺
1026	20 cm Yedek	25	AD	21,64 ₺
1027	25 cm Yedek	25	AD	23,99 ₺

### SÜPERLÜKS RULO

KOD	ÜRÜN ADI	KOLİ	BİRİM	FİYAT
1001	20 cm	25	AD	27,16 ₺
1003	25 cm	25	AD	29,78 ₺
1020	20 cm Yedek	25	AD	21,64 ₺
1022	25 cm Yedek	25	AD	23,99 ₺

**PÖSTEKİ RULO**

KOD	ÜRÜN ADI	KOLİ	BİRİM	FİYAT
1035	20 cm	12	12	71,69 ₺
1036	25 cm	12	12	83,41 ₺
1050	20 cm Yedek	25	12	66,17 ₺
1051	25 cm Yedek	25	12	77,62 ₺

**KAZIMA RASPA**

KOD	ÜRÜN ADI	KOLİ	BİRİM	FİYAT
1202	10x20 cm	12	AD	39,43 ₺
1203	20x20 cm	12	AD	48,94 ₺
1205	30x25 cm	12	AD	56,25 ₺

**OYNAR BAŞLIKLİ ZİMPARA MALASI**

KOD	ÜRÜN ADI	KOLİ	BİRİM	FİYAT
1207	9x22,5 cm	12	AD	31,57 ₺

**SABİT BAŞLIKLİ ZİMPARA MALASI**

KOD	ÜRÜN ADI	KOLİ	BİRİM	FİYAT
1206	9x22,5 cm	12	AD	29,09 ₺

**AYARLI ALÜMİNYUM HAFİF SIRIK**

KOD	ÜRÜN ADI	KOLİ	BİRİM	FİYAT
1292	2 mt - 2 Kademe	12	AD	47,15 ₺
1294	3 mt - 2 Kademe	12	AD	63,55 ₺
1296	4 mt - 3 Kademe	8	AD	105,33 ₺
1297	6 mt - 3 Kademe	6	AD	140,48 ₺



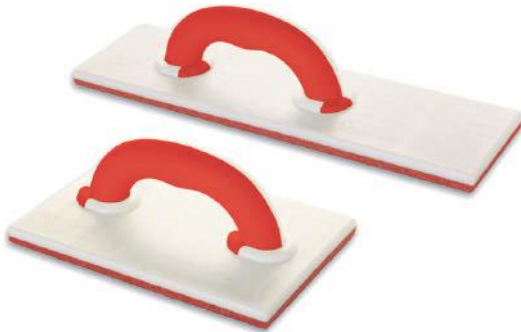

## MACUN İSPATULASI

KOD	ÜRÜN ADI	KOLİ	BİRİM	FİYAT
001	6 cm	12	AD	19,24 ₺
002	8 cm	12	AD	19,32 ₺
003	10 cm	12	AD	20,08 ₺
004	11 cm	12	AD	22,34 ₺
005	12 cm	12	AD	23,52 ₺
006	14 cm	12	AD	26,04 ₺
008	16 cm	12	AD	27,97 ₺
010	18 cm	12	AD	28,81 ₺

## SIVA MALASI

KOD	ÜRÜN ADI	KOLİ	BİRİM	FİYAT
058	14 cm	12	AD	25,87 ₺
059	16 cm	12	AD	27,05 ₺
060	18 cm	12	AD	28,90 ₺
061	20 cm	12	AD	29,90 ₺
062	22 cm	12	AD	31,67 ₺
063	24 cm	12	AD	31,92 ₺
064	26 cm	12	AD	32,26 ₺

## MACUN KÜREĞİ

KOD	ÜRÜN ADI	KOLİ	BİRİM	FİYAT
055	YAY ÇELİĞİ 16 cm	12	AD	29,99 ₺
056	YAY ÇELİĞİ 18 cm	12	AD	32,09 ₺
057	YAY ÇELİĞİ 20 cm	12	AD	34,78 ₺
242	PASLANMAZ 18 cm	12	AD	45,36 ₺
243	PASLANMAZ 20 cm	12	AD	49,90 ₺

## TIRFIL MALA

KOD	ÜRÜN ADI	KOLİ	BİRİM	FİYAT
077	KISA	12	AD	26,54 ₺
078	UZUN	12	AD	27,72 ₺

## ALÇI KÜREĞİ PLASTİK SAPLI

KOD	ÜRÜN ADI	KOLİ	BİRİM	FİYAT
114	30x24 cm	12	AD	42,00 ₺

## SÜNGERLİ MALA

KOD	ÜRÜN ADI	KOLİ	BİRİM	FİYAT
180	16x30 cm	12	AD	34,27 ₺
182	14x28 cm	12	AD	33,60 ₺

## MARLEY MALASI

KOD	ÜRÜN ADI	KOLİ	BİRİM	FİYAT
131	30 cm	12	AD	35,45 ₺

## ŞAP MALASI

KOD	ÜRÜN ADI	KOLİ	BİRİM	FİYAT
075	55 cm	12	AD	37,63 ₺

## SERAMİK MALASI

KOD	ÜRÜN ADI	KOLİ	BİRİM	FİYAT
230	8x8 30 cm	12	AD	36,71 ₺
232	8x8 40 cm	12	AD	36,71 ₺
234	8x8 50 cm	12 <td AD	36,71 ₺	
430	10x10 30 cm	12	AD	36,71 ₺
432	10x10 40 cm	12	AD	36,71 ₺
434	10x10 50 cm	12	AD	36,71 ₺

## SERAMİK MALASI

KOD	ÜRÜN ADI	KOLİ	BİRİM	FİYAT
128	8x8 30 cm	12	AD	36,71 ₺
124	8x8 40 cm	12	AD	39,31 ₺
404	10x10 30 cm	12	AD	39,31 ₺
166	10x10 35 cm	12	AD	39,31 ₺

## DERZ MALASI

KOD	ÜRÜN ADI	KOLİ	BİRİM	FİYAT
128	KISA	12	AD	36,71 ₺
124	UZUN	12	AD	39,31 ₺

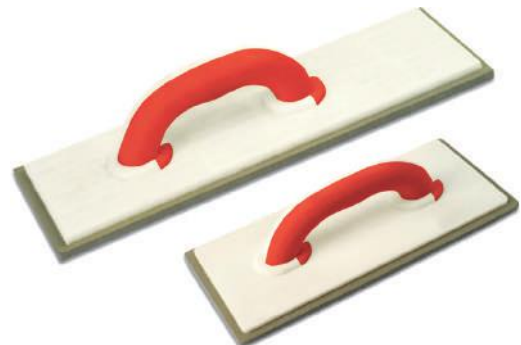



## EĞRİ SAPLI İSPATULA

KOD	ÜRÜN ADI	KOLİ	BİRİM	FİYAT
045	YAY ÇELİĞİ 20 cm	12	AD	31,33 ₺
046	YAY ÇELİĞİ 25 cm	12	AD	32,34 ₺
047	YAY ÇELİĞİ 30 cm	12	AD	35,20 ₺
048	YAY ÇELİĞİ 40 cm	12	AD	43,09 ₺
049	YAY ÇELİĞİ 50 cm	12	AD	48,22 ₺
145	PASLANMAZ 20 cm	12	AD	40,07 ₺
146	PASLANMAZ 25 cm	12	AD	41,92 ₺
147	PASLANMAZ 30 cm	12	AD	42,50 ₺
148	PASLANMAZ 40 cm	12	AD	48,30 ₺
149	PASLANMAZ 50 cm	12	AD	59,05 ₺

## ALÇI MALASI

KOD	ÜRÜN ADI	KOLİ	BİRİM	FİYAT
212	40 cm	12	AD	36,62 ₺
214	50 cm	12	AD	40,32 ₺

## ALÇI MALASI

KOD	ÜRÜN ADI	KOLİ	BİRİM	FİYAT
091	YAY ÇELİĞİ 30 cm	12	AD	34,44 ₺
093	YAY ÇELİĞİ 35 cm	12	AD	37,13 ₺
092	PASLANMAZ 30 cm	12	AD	46,37 ₺
094	PASLANMAZ 35 cm	12	AD	47,71 ₺

## SIVACI KÜREĞİ

KOD	ÜRÜN ADI	KOLİ	BİRİM	FİYAT
076	36x44 cm	12	AD	40,66 ₺

## SERPME KÜREĞİ

KOD	ÜRÜN ADI	KOLİ	BİRİM	FİYAT
072	21,5x20x40 cm	12	AD	15,37 ₺

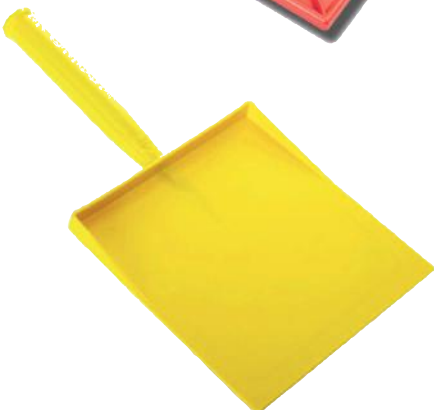

## SIVA VE ALÇI MALASI

KOD	ÜRÜN ADI	KOLİ	BİRİM	FİYAT
080	50 LT	12	AD	81,48 ₺
081	35 LT	12	AD	61,15 ₺

## ELASTİK KOVA

KOD	ÜRÜN ADI	KOLİ	BİRİM	FİYAT
576	15 LT	12	AD	50,99 ₺
577	25 LT	12	AD	43,26 ₺

## ALÇI RENDESİ

KOD	ÜRÜN ADI	KOLİ	BİRİM	FİYAT
111	46x9x1.9 cm	6	AD	132,49 ₺

## ALÇI SİSTRE

KOD	ÜRÜN ADI	KOLİ	BİRİM	FİYAT
116	30 cm	12	AD	28,81 ₺
117	35 cm	12	AD	35,20 ₺

## ÇELİK SİSTRE

KOD	ÜRÜN ADI	KOLİ	BİRİM	FİYAT
054	YAY ÇELİĞİ 6x15 cm	12	AD	6,22 ₺
274	PASLANMAZ 6x15 cm	12	AD	9,07 ₺

## DİZLİK POLİÜRETAN

KOD	ÜRÜN ADI	KOLİ	BİRİM	FİYAT
318	14 cm	12	AD	52,25 ₺

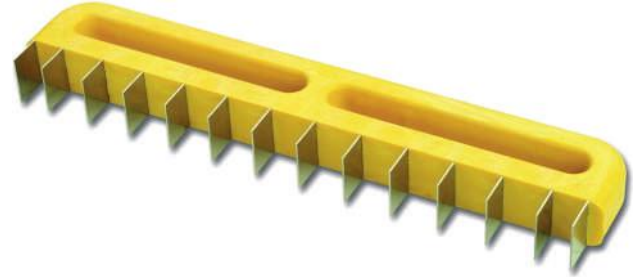



## ŞERİT METRE

KOD	ÜRÜN ADI	KOLİ	BİRİM	FİYAT
294	3x16	12	AD	24,96 ₺
295	5x19	12	AD	32,54 ₺
296	5x25	12	AD	36,19 ₺
297	8x25	12	AD	48,00 ₺
298	10x25	12	AD	57,12 ₺

## ŞERİT METRE SOFT

KOD	ÜRÜN ADI	KOLİ	BİRİM	FİYAT
304	3x16	12	AD	30,34 ₺
305	5x19	12	AD	37,92 ₺
306	5x25	12	AD	41,95 ₺
307	8x25	12	AD	54,05 ₺

## METRO KESTİRME FIRÇA

KOD	ÜRÜN ADI	KOLİ	BİRİM	FİYAT
08.04.001	1	12/120	AD	5,30 ₺
08.04.002	1,5	12/120	AD	7,50 ₺
08.04.003	2	12/120	AD	9,28 ₺
08.04.004	2,5	12/120	AD	12,15 ₺
08.04.005	3	12/120	AD	14,57 ₺
08.04.006	4	12/120	AD	17,66 ₺

## KAPTAN KESTİRME FIRÇA

KOD	ÜRÜN ADI	KOLİ	BİRİM	FİYAT
08.04.023	1	12/120	AD	2,65 ₺
08.04.024	1,5	12/120	AD	3,75 ₺
08.04.025	2	12/120	AD	4,64 ₺
08.04.026	2,5	12/120	AD	6,07 ₺
08.04.027	3	12/120	AD	6,62 ₺
08.04.028	4	12/120	AD	8,83 ₺

## KESTİRME FIRÇA LÜX

KOD	ÜRÜN ADI	KOLİ	BİRİM	FİYAT
08.04.011	1	12/120	AD	12,36 ₺
08.04.012	1,5	12/120	AD	14,57 ₺



### YAĞLI BOYA FIRÇA

KOD	ÜRÜN ADI	KOLİ	BİRİM	FİYAT
08.04.013	1	12/120	AD	4,69 ₺
08.04.014	1,5	12/120	AD	6,07 ₺
08.04.015	2	12/120	AD	8,83 ₺
08.04.016	2,5	12/120	AD	11,70 ₺
08.04.017	3	12/120	AD	14,63 ₺
08.04.018	4	12/120	AD	18,77 ₺



### KALORİFER FIRÇASI

KOD	ÜRÜN ADI	KOLİ	BİRİM	FİYAT
08.04.021	2	12/120	AD	6,07 ₺
08.04.022	3	12/120	AD	8,83 ₺



### ROBOT FIRÇA

KOD	ÜRÜN ADI	KOLİ	BİRİM	FİYAT
08.04.019	3	12/120	AD	13,25 ₺
08.04.020	4	12/120	AD	15,46 ₺



### SATEN RULO

KOD	ÜRÜN ADI	KOLİ	BİRİM	FİYAT
08.03.003	20 cm	25	AD	11,04 ₺
08.03.004	25 cm	25	AD	11,59 ₺



### PLASTİK RULO

KOD	ÜRÜN ADI	KOLİ	BİRİM	FİYAT
08.03.001	20 cm	25	AD	11,04 ₺
08.03.002	25 cm	25	AD	11,59 ₺



### PARMAK RULO

KOD	ÜRÜN ADI	KOLİ	BİRİM	FİYAT
08.03.005	20 cm	25	AD	4,42 ₺

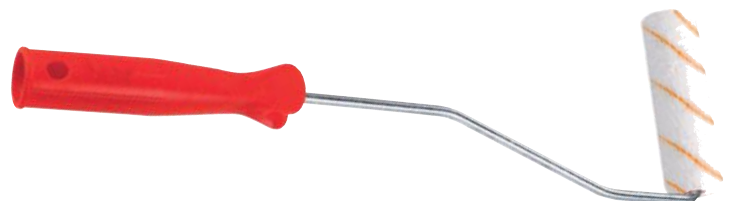





### PARMARULO YEDEK

KOD	ÜRÜN ADI	KOLİ	BİRİM	FİYAT
08.03.005	20 cm	25	AD	4,42 ₺



### ZİFT & İZOLASYON FIRÇASI

KOD	ÜRÜN ADI	KOLİ	BİRİM	FİYAT
08.03.001	20 cm	25	AD	11,04 ₺
08.03.002	25 cm	25	AD	11,59 ₺



### PLASTİK BADANA FIRÇASI

KOD	ÜRÜN ADI	KOLİ	BİRİM	FİYAT
08.04.032	KISA YELE	12	AD	17,66 ₺
08.04.033	UZUN YELE	12	AD	17,66 ₺



### SU SERPME FIRÇASI

KOD	ÜRÜN ADI	KOLİ	BİRİM	FİYAT
08.04.029	PLASTİK KIL	12	AD	9,94 ₺



**KORUYUCU HIŞIR ÖRTÜ**  
PROTECTIVE COVER SHEET 4x2,5 = 10 m<sup>2</sup>



- Kullanımı pratiktir.
- Çevreyi kirletmez.
- Yanıcıdır.
- Çocuklardan uzak tutunuz.
- Easy to use
- Environmentally friendly.
- Inflammable.
- Keep out of reach of children.



### HIŞIR ÖRTÜ

KOD	ÜRÜN ADI	KOLİ	BİRİM	FİYAT
08.01.001	10 M <sup>2</sup>	25	AD	0,36 \$
08.01.002	20 M <sup>2</sup>	25	AD	0,62 \$
08.01.003	32 M <sup>2</sup>	25	AD	0,91 \$
08.01.004	50 M <sup>2</sup>	25	AD	1,34 \$



**KALIN ZEMİN ÖRTÜ**  
THICK GROUND COVER 4x2,5 = 10 m<sup>2</sup>



- Kullanımı pratiktir.
- Çevreyi kirletmez.
- Yanıcıdır.
- Çocuklardan uzak tutunuz.
- Easy to use
- Environmentally friendly.
- Inflammable.
- Keep out of reach of children.



### KALIN ÖRTÜ

KOD	ÜRÜN ADI	KOLİ	BİRİM	FİYAT
08.02.001	10 M <sup>2</sup>	20	AD	0,67 \$
08.02.002	20 M <sup>2</sup>	20	AD	1,27 \$
08.02.003	32 M <sup>2</sup>	20	AD	1,99 \$
08.02.004	50 M <sup>2</sup>	12	AD	2,95 \$

### BOYA KARIŐTIRICI (SDS)

KOD	ÜRÜN ADI	KOLİ	BİRİM	FİYAT
08.05.072	80x400	60	AD	3,25 \$
08.05.073	100x450	30	AD	3,44 \$
08.05.074	120x500	30	AD	3,77 \$



### BOYA KARIŐTIRICI (HEX)

KOD	ÜRÜN ADI	KOLİ	BİRİM	FİYAT
08.05.075	60x400	72	AD	1,84 \$
08.05.076	85x400	50	AD	2,02 \$
08.05.077	100x600	20	AD	3,21 \$
08.05.076	120x600	20	AD	2,02 \$



### BOYA KARIŐTIRICI (M14)

KOD	ÜRÜN ADI	KOLİ	BİRİM	FİYAT
08.05.079	80x400	60	AD	7,11 \$



### RULO ELEĐİ

KOD	ÜRÜN ADI	KOLİ	BİRİM	FİYAT
08.05.071	80x400	60	AD	3,40 ₺



### SPATULA

KOD	ÜRÜN ADI	KOLİ	BİRİM	FİYAT
08.04.013	1	12/120	AD	4,69 ₺
08.04.014	1,5	12/120	AD	6,07 ₺
08.04.015	2	12/120	AD	8,83 ₺
08.04.016	2,5	12/120	AD	11,70 ₺
08.04.017	3	12/120	AD	14,63 ₺
08.04.018	4	12/120	AD	18,77 ₺



### SIVA MALASI

KOD	ÜRÜN ADI	KOLİ	BİRİM	FİYAT
08.05.053	18	12	AD	14,20 ₺
08.05.054	20	12	AD	15,12 ₺
08.05.055	22	12	AD	16,74 ₺
08.05.056	24	12	AD	17,06 ₺





### ŞAP MALASI

KOD	ÜRÜN ADI	KOLİ	BİRİM	FİYAT
08.05.041	10x50 KAPALI	12	AD	26,89 ₺
08.05.042	10x50 AÇIK	12	AD	21,92 ₺



### PROFESYONEL MACUN KÜREĞİ

KOD	ÜRÜN ADI	KOLİ	BİRİM	FİYAT
08.05.016	16	12	AD	18,74 ₺
08.05.017	18	12	AD	20,41 ₺
08.05.018	20	12	AD	22,36 ₺



### SIVACI KÜREĞİ

KOD	ÜRÜN ADI	KOLİ	BİRİM	FİYAT
08.05.051	35x45	12	AD	29,48 ₺



### MACUN SPATULA

KOD	ÜRÜN ADI	KOLİ	BİRİM	FİYAT
08.05.001	4	12	AD	8,53 ₺
08.05.002	6	12	AD	10,42 ₺
08.05.003	8	12	AD	11,18 ₺
08.05.004	10	12	AD	12,85 ₺
08.05.005	12	12	AD	15,28 ₺
08.05.006	14	12	AD	15,93 ₺
08.05.007	16	12	AD	16,63 ₺
08.05.008	18	12	AD	17,71 ₺



### SIRIK SPATULA

KOD	ÜRÜN ADI	KOLİ	BİRİM	FİYAT
08.05.009	6	12	AD	6,80 ₺
08.05.010	8	12	AD	59,40 ₺
08.05.011	10	12	AD	8,75 ₺
08.05.012	12	12	AD	9,67 ₺
08.05.013	14	12	AD	10,21 ₺
08.05.014	16	12	AD	10,58 ₺
08.05.015	18	12	AD	11,50 ₺

### PLASTİK SAPLI ALÇI MALASI

KOD	ÜRÜN ADI	KOLİ	BİRİM	FİYAT
08.05.024	12x30	12	AD	22,25 ₺
08.05.025	12x35	12	AD	24,35 ₺
08.05.026	12x40	12	AD	25,54 ₺



### PLS.SAP KARE DİŞLİ SEMAMİK MALASI

KOD	ÜRÜN ADI	KOLİ	BİRİM	FİYAT
08.05.033	8x8 - 12x30	12	AD	32,72 ₺
08.05.034	8x8 - 12x35	12	AD	37,37 ₺
08.05.035	8x8 - 12x40	12	AD	41,15 ₺
08.05.036	10x10 - 12x30	12	AD	22,25 ₺
08.05.037	10x10 - 12x35	12	AD	24,35 ₺
08.05.038	10x10 - 12x40	12	AD	25,54 ₺



### PLS.SAP KARE DİŞLİ SERAMİK MALASI

KOD	ÜRÜN ADI	KOLİ	BİRİM	FİYAT
08.05.027	8x8 - 12x30	12	AD	23,33 ₺
08.05.028	8x8 - 12x35	12	AD	24,84 ₺
08.05.029	8x8 - 12x40	12	AD	26,35 ₺
08.05.030	10x10 - 12x30	12	AD	23,33 ₺
08.05.031	10x10 - 12x35	12	AD	24,84 ₺
08.05.032	10x10 - 12x40	12	AD	26,35 ₺



### DERZ MALASI

KOD	ÜRÜN ADI	KOLİ	BİRİM	FİYAT
08.05.047	KISA	12	AD	25,54 ₺
08.05.048	UZUN	12	AD	27,05 ₺



### SÜNGERLİ MALA

KOD	ÜRÜN ADI	KOLİ	BİRİM	FİYAT
08.05.043	17x24	12	AD	24,95 ₺
08.05.044	13x28	12	AD	25,70 ₺

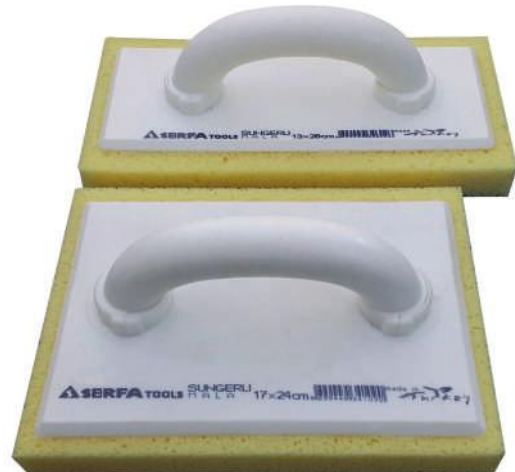





### EĞRİ SAPLI SPATULA

KOD	ÜRÜN ADI	KOLİ	BİRİM	FİYAT
08.05.019	20	12	AD	16,52 ₺
08.05.020	25	12	AD	17,44 ₺
08.05.021	30	12	AD	19,12 ₺
08.05.022	40	12	AD	23,44 ₺
08.05.023	50	12	AD	26,46 ₺

### OTO SPATULASI 4'LÜ TAKIM

KOD	ÜRÜN ADI	KOLİ	BİRİM	FİYAT
08.05.060	5-8-10-12	12	AD	16,19 ₺

### ZIMPARA MALASI

KOD	ÜRÜN ADI	KOLİ	BİRİM	FİYAT
08.05.039	SABİT BAŞLI	12	AD	20,25 ₺
08.05.040	OYNAR BAŞLI	12	AD	20,14 ₺

### KALE TERASİT MALASI

KOD	ÜRÜN ADI	KOLİ	BİRİM	FİYAT
08.05.052	12,5x27,5	12	AD	15,11

### SIVA VE ALÇI TEKNESİ

KOD	ÜRÜN ADI	KOLİ	BİRİM	FİYAT
08.05.100	35 LT	1	AD	43,85
08.05.101	50 LT	1	AD	

### TIRFİL MALA

KOD	ÜRÜN ADI	KOLİ	BİRİM	FİYAT
08.05.045	KISA	12	AD	19,66 ₺
08.05.046	UZUN	12	AD	21,49 ₺



# İŞ GÜVENLİĞİ





### İŞ AYAKKABISI

KOD	ÜRÜN ADI	KOLİ	BİRİM	FİYAT
09.01.003	40 NO	20	AD	18,95 \$
09.01.004	41 NO	20	AD	18,95 \$
09.01.005	42 NO	20	AD	18,95 \$
09.01.006	43 NO	20	AD	18,95 \$
09.01.007	44 NO	20	AD	18,95 \$
09.01.008	45 NO	20	AD	18,95 \$

### İŞ AYAKKABISI YAZLIK

KOD	ÜRÜN ADI	KOLİ	BİRİM	FİYAT
09.01.009	38 NO	20	AD	23,69 \$
09.01.011	40 NO	20	AD	23,69 \$
09.01.012	41 NO	20	AD	23,69 \$
09.01.013	42 NO	20	AD	23,69 \$
09.01.014	43 NO	20	AD	23,69 \$
09.01.015	44 NO	20	AD	23,69 \$
09.01.016	45 NO	20	AD	23,69 \$

### GEZER ÇİZME KISA

KOD	ÜRÜN ADI	KOLİ	BİRİM	FİYAT
09.01.017	40 NO	14	AD	51,84 ₺
09.01.018	41 NO	14	AD	51,84 ₺
09.01.019	42 NO	14	AD	51,84 ₺
09.01.020	43 NO	14	AD	51,84 ₺
09.01.021	44 NO	14	AD	51,84 ₺
09.01.022	45 NO	14	AD	51,84 ₺

### GEZER ÇİZME UZUN

KOD	ÜRÜN ADI	KOLİ	BİRİM	FİYAT
09.01.138	40 NO	14	AD	55,56 ₺
09.01.139	41 NO	14	AD	55,56 ₺
09.01.140	42 NO	14	AD	55,56 ₺
09.01.135	43 NO	14	AD	55,56 ₺
09.01.136	44 NO	14	AD	55,56 ₺
09.01.141	45 NO	14	AD	55,56 ₺

### İKAZ YELEĞİ

KOD	ÜRÜN ADI	KOLİ	BİRİM	FİYAT
09.01.030	SARI	10	AD	10,80 ₺
09.01.031	TURUNCU	10	AD	10,80 ₺



### MÜHENDİS YELEĞİ

KOD	ÜRÜN ADI	KOLİ	BİRİM	FİYAT
09.01.032	SARI	10	AD	27,60 ₺
09.01.033	TURUNCU	10	AD	27,60 ₺



### BARET

KOD	ÜRÜN ADI	KOLİ	BİRİM	FİYAT
09.01.034	SARI	20	AD	15,60 ₺
09.01.035	BEYAZ	20	AD	15,60 ₺
09.01.036	MAVİ	20	AD	15,60 ₺
09.01.037	SARI AYARLI	20	AD	20,40 ₺
09.01.038	BEYAZ AYARLI	20	AD	20,40 ₺
09.01.039	MAVİ AYARLI	20	AD	20,40 ₺



### YAĞMURLUK

KOD	ÜRÜN ADI	KOLİ	BİRİM	FİYAT
09.01.025	SARI	10	AD	7,07 \$



### GEZER BOT

KOD	ÜRÜN ADI	PAKET	BİRİM	FİYAT
09.01.075	40 NO	1	AD	63,60 ₺
09.01.076	41 NO	1	AD	63,60 ₺
09.01.077	42 NO	1	AD	63,60 ₺
09.01.078	43 NO	1	AD	63,60 ₺
09.01.079	44 NO	1	AD	63,60 ₺
09.01.080	45 NO	1	AD	63,60 ₺







### EMNİYET KEMERİ

KOD	ÜRÜN ADI	KOLİ	BİRİM	FİYAT
09.01.042	BEL DESTEKLİ	50	AD	93,60 ₺
09.01.043	BEL DESTEKSİZ	50	AD	72,00 ₺
09.01.044	BEL TİPİ	50	AD	72,00 ₺



### VENTİLLİ TOZ MASKESİ

KOD	ÜRÜN ADI	KOLİ	BİRİM	FİYAT
09.01.040	KUBBE TİP	25/500	AD	
09.01.041	KATLANIR TİP	25/500	AD	

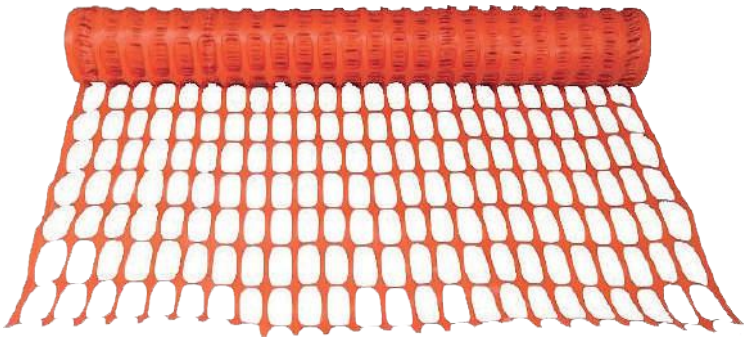

### ALAN PERDESİ

KOD	ÜRÜN ADI	KOLİ	BİRİM	FİYAT
09.01.081	YERLİ	6	AD	62,40 ₺

### KAYNAK MASKESİ

KOD	ÜRÜN ADI	KOLİ	BİRİM	FİYAT
09.01.047	PLASTİK	50	AD	19,15 ₺



### MASKE CAMI

KOD	ÜRÜN ADI	KOLİ	BİRİM	FİYAT
09.01.049	GENİŞ 777	100/500	AD	0,26 \$
09.01.050	GENİŞ 787	100/500	AD	0,26 \$
09.01.051	GENİŞ 888	100/500	AD	0,26 \$
09.01.053	DAR 787	100/500	AD	0,26 \$
09.01.054	DAR 888	100/500	AD	0,26 \$



### ÇAPAK GÖZLÜĞÜ

KOD	ÜRÜN ADI	KOLİ	BİRİM	FİYAT
09.01.044	ŞEFFAF	12/600	AD	4,20 ₺
09.01.045	SİYAH	12/600	AD	4,20 ₺
09.01.046	FÜME	12/600	AD	4,20 ₺
09.01.083	KIRMIZI	12/600	AD	4,44 ₺
09.01.047	SARI	12/600	AD	4,20 ₺



### KAYNAK PENSESİ

KOD	ÜRÜN ADI	KOLİ	BİRİM	FİYAT
04.10.001	400 AMPER	60	AD	5,24 \$
04.10.002	600 AMPER	60	AD	7,87 \$



### ŞASE PENSESİ

KOD	ÜRÜN ADI	KOLİ	BİRİM	FİYAT
04.23.013	300 AMPER	15	AD	3,70 \$
04.23.016	500 AMPER	5	AD	5,53 \$





\*Yükleme \*Taşıma,  
\*Tarım \*Bahçe





\*Yükleme \*Taşıma,  
\*Taşıma \*Tarım \*Bahçe



\*Endüstriyel  
\*Montaj \*Mekanik

## NİTRİL KAPLI PAMUKLU ELDİVEN

KOD	ÜRÜN ADI	KOLİ	BİRİM	FİYAT
	Kn350 No:9-10	288	AD	
	Kn1 No:9-10	288	AD	
	Kn2 No:9-10	288	AD	
	Kn2+ No:9-10	288	AD	
	Kn6 No:9-10	288	AD	



\*Endüstriyel  
\*Metal





\*Endüstriyel  
\*Rafine





\*Hafif Sanayi  
\*Yükleme \*Boşaltma,  
\*Tarım \*Depolama

## NİTRİL KAPLI POLYESTER ELDİVEN

KOD	ÜRÜN ADI	KOLİ	BİRİM	FİYAT
	Pn7 No:9-10	288	AD	
	Pn72 No:9-10	288	AD	
	Pn75 No:9-10	288	AD	
	Pn Zebra No:9-10	288	AD	



\*Otomotiv \*Montaj  
\*Depolama \*Ambalaj







- \*Su Bazlı Poliüretan Montaj Eldiveni
- \*Kimyasal için sıvı temasını önler
- \*Gıdaya temasa uygundur.
- \*Mükemmel Ömür

### MONTAJ ELDİVENİ

KOD	ÜRÜN ADI	KOLİ	BİRİM	FİYAT
	YU150 NO:7-8-9-10	288	AD	



- \*Cam İşleri
- \*Montaj

### LATEKS KAPLI ÖRGÜ POLYESTER ELDİVEN





KOD	ÜRÜN ADI	KOLİ	BİRİM	FİYAT
	PI9 NO:9-10	288	AD	

\*Bağ Bahçe  
\*Tarım  
\*Ev



\*Ev \*Boya  
\*Bahçe  
\*Temizlik

## KORUN İŞ ELDİVENİ

KOD	ÜRÜN ADI	KOLİ	BİRİM	FİYAT
	USTA İŞİ 7-7,5 / 8-8,5 / 9-9,5 / 10-10,5	288	AD	
	EKONOMİK 7-7,5 / 8-8,5 / 9-9,5 / 10-10,5	288	AD	
	KORUN TURUNCU 9 / 9,5 / 10	288	AD	
	NTL-33 33 cm - 38 cm	288	AD	



\*Tuğla  
\*Briket İmalatı





\*Kimyasala Karşı Dirençli  
\*Aşınma ve Delinmeye Karşı  
Dayanıklı  
\*Kimyasal İşleme  
\*Petrol Rafinesi  
\*Tarım İlaçlama





\*Steril Değildir \* Pudrasız  
\*Gıdaya Uygunur

### Gıda Eldiveni

KOD	ÜRÜN ADI	PAKET	BİRİM	FİYAT
	DİAMOND MAVİ S-M-L-XL	50	AD	
	DİAMOND SİYAH S-M-L-XL	50	AD	



\*Steril Değildir \* Pudrasız  
\*Gıdaya Uygunur



\*Steril Değildir \* Pudralı  
\*Tek Kullanımlık

### Muayene Eldiveni

KOD	ÜRÜN ADI	PAKET	BİRİM	FİYAT
	S-M-L	100	AD	





# YÜKÜNÜZÜ HAFİFLETMENİN KOLAY YOLU





**NİTRİL ELDİVEN**

KOD	ÜRÜN ADI	KOLİ	BİRİM	FİYAT
09.01.055	NO:9	300	AD	5,76 ₺
09.01.056	NO:10	300	AD	5,76 ₺

**NİTRİL NAYLON ELDİVEN GRİ**

KOD	ÜRÜN ADI	KOLİ	BİRİM	FİYAT
09.01.057	NO:9	300	AD	5,76 ₺
09.01.058	NO:10	300	AD	5,76 ₺

**NİTRİL NAYLON ELDİVEN SİYAH**

KOD	ÜRÜN ADI	KOLİ	BİRİM	FİYAT
09.01.059	NO:9	300	AD	4,44 ₺
09.01.060	NO:10	300	AD	4,44 ₺

**POLİÜRETAN ELDİVEN SİYAH**

KOD	ÜRÜN ADI	KOLİ	BİRİM	FİYAT
09.01.065	NO:8	300	AD	1,18 \$
09.01.066	NO:9	300	AD	1,18 \$

### LATEKS ELDİVEN KIRMIZI SİYAH TIRTIKLI

KOD	ÜRÜN ADI	KOLİ	BİRİM	FİYAT
09.01.063	NO:9	300	AD	6,36 ₺
09.01.064	NO:10	300	AD	6,36 ₺



### KAYNAKÇI ELDİVENİ

KOD	ÜRÜN ADI	KOLİ	BİRİM	FİYAT
09.01.070	NO:14	300	AD	6,46 \$



### PETROLÇÜ ELDİVENİ

KOD	ÜRÜN ADI	KOLİ	BİRİM	FİYAT
09.01.071	NO:10	120	AD	3,48 \$



### DERİ ELDİVEN



KOD	ÜRÜN ADI	KOLİ	BİRİM	FİYAT
09.01.118	NO:10,5	120	AD	2,48 \$



**DERİ ELDİVEN TAKVIYELİ**

KOD	ÜRÜN ADI	KOLİ	BİRİM	FİYAT
09.01.069	NO:14	60	AD	3,53 \$

**MUAYENE ELDİVENİ**

KOD	ÜRÜN ADI	KOLİ	BİRİM	FİYAT
09.04.001	S	100	AD	
09.04.002	M	100	AD	
09.04.003	L	100	AD	

**LASTİK ELDİVEN**

KOD	ÜRÜN ADI	KOLİ	BİRİM	FİYAT
09.02.001	8-8,5	120	AD	0,87 \$
09.02.002	9-9,5	120	AD	0,87 \$
09.02.003	10-10,5	120	AD	0,87 \$



# KALDIRMA EKİPMANLARI







### ŞİŞE KRİKO

KOD	ÜRÜN ADI	KOLİ	BİRİM	FİYAT
10.01.001	2 TON	10	AD	16,56 \$
10.01.002	3 TON	8	AD	20,70 \$
10.01.003	5 TON	6	AD	25,39 \$
10.01.004	8 TON	4	AD	31,74 \$
10.01.005	10 TON	4	AD	34,22 \$
10.01.006	12 TON	2	AD	43,06 \$
10.01.007	15 TON	2	AD	51,89 \$
10.01.008	20 TON	2	AD	57,96 \$
10.01.009	30 TON	2	AD	112,61 \$
10.01.010	50 TON	1	AD	177,74 \$

### CERASKAL

KOD	ÜRÜN ADI	KOLİ	BİRİM	FİYAT
10.01.013	0.5 TON 3MT	1	AD	83,39 \$
10.01.014	1 TON 3MT	1	AD	85,48 \$
10.01.015	2 TON 3MT	1	AD	105,93 \$
10.01.016	3 TON 3MT	1	AD	159,42 \$
10.01.017	0.5 TON 5MT	1	AD	101,21 \$
10.01.018	1 TON 5MT	1	AD	103,31 \$
10.01.019	2 TON 5MT	1	AD	135,30 \$
10.01.020	3 TON 5MT	1	AD	199,27 \$
10.01.021	5 TON 5MT	1	AD	289,47 \$

### ARABALI KRİKO

KOD	ÜRÜN ADI	KOLİ	BİRİM	FİYAT
09.01.084	KARTON KUTU 2 TON	1	AD	43,06 \$
09.01.085	PLASTİK KUTU 2 TON	1	AD	46,37 \$
	PEDALLI 3 TON	1	AD	181,06 \$

### TRANSPALET

KOD	ÜRÜN ADI	KOLİ	BİRİM	FİYAT
10.01.027	2,5 TON	1	AD	

### MAKASLI KRİKO

KOD	ÜRÜN ADI	KOLİ	BİRİM	FİYAT
10.01.022	1,5 TON	2	AD	16,78 \$



# ELEKTRİKLİ EL ALETLERİ



### MXP2940 AKÜLÜ MATKAP

20V - 2.0 AMPER

ÇİFT AKÜ

ÇİFT VİTES

16 KADEME TORK

1. VİTES 0-500 / 2. VİTES 0-1700 rpm

13 MM OTOMATİK METAL MANDREN

**547,00 \$**



**603,00 \$**

### MXP2940D DARBELİ AKÜLÜ MATKAP

20V - 2.0 AMPER

ÇİFT AKÜ

ÇİFT VİTES

16 KADEME TORK

1. VİTES 0-500 / 2. VİTES 0-1700 rpm

13 MM OTOMATİK METAL MANDREN

### MXP5343 DARBELİ

600 WATT

220 VOLT

0-2800 DEVİR / DAKİKA

13 MM MANDREN

**56,68 \$**



**MXP10112 AVUÇ TAŞLAMA**

1020 WATT

220 VOLT

11000 DEVİR / DAKİKA

115 MM DİSK ÇAPI



**139,00 \$**



**MXP21400 TAŞLAMA**

2400 WATT

220 VOLT

8000 DEVİR / DAKİKA

180 MM DİSK ÇAPI

**147,67 \$**

**125,29 \$**

**MXP3070 POLİSAJ**

1200 WATT

220 VOLT

600-3700 ELEKTRONİK DEVİR AYARI

180 MM DİSK ÇAPI





**MXP4190 SUNTA KESME**

1300 WATT

220 VOLT

190 MM TESTERE ÇAPI



**184,00 \$**



**MXP4950 TILKI KUYRUĞU TESTERESİ**

1200 WATT

220 VOLT

800-2700 ELEKTRONİK DEVİR AYARI

3 KADEME ORBİTAL - 1KADEME DÜZ AYAR

**437,00 \$**

**MXP3553 PROFİL KESME**

2300 WATT

220 VOLT

3900 DEVİR AYARI

355 MM DİSK ÇAPI



**233,00 \$**

### MX1215 AKÜLÜ MATKAP

12V - 1.5 AMPER

ÇİFT AKÜ

ÇİFT VİTES

18 KADEME TORK

1. VİTES 0-350 / 2. VİTES 0-1200 rpm

10 MM OTOMATİK METAL MANDREN



**MaxExtra**  
**Lithium-Ion**

**67,12 \$**



**MaxExtra**  
**Lithium-Ion**

**73,00\$**

### MX1250 AKÜLÜ MATKAP

12V - 1.5 AMPER

ÇİFT AKÜ

ÇİFT VİTES

18 KADEME TORK

1. VİTES 0-350 / 2. VİTES 0-1200 rpm

10 MM OTOMATİK METAL MANDREN

### MX1450 AKÜLÜ MATKAP

14V - 1.5 AMPER

ÇİFT AKÜ

ÇİFT VİTES

18 KADEME TORK

1. VİTES 0-350 / 2. VİTES 0-1400 rpm

10 MM OTOMATİK METAL MANDREN

**83,53 \$**

**MaxExtra**  
**Lithium-Ion**



**MX1825D AKÜLÜ MATKAP**

18V - 1.3 AMPER

ÇİFT AKÜ

ÇİFT VİTES

18 KADEME TORK

1. VİTES 0-400 / 2. VİTES 0-1800 rpm

10 MM OTOMATİK METAL MANDREN



**MaxExtra**  
Lithium-Ion

**117,84 \$**



**MX0525 DARBELİ MATKAP**

600 WATT

220 VOLT

0-3000 DEVİR / DAKİKA

13 MM MANDREN

**35,80 \$**

**MX2603 SDS PLUS DELİCİ KIRICI**

800 WATT

220 VOLT

2.9 JUL KIRMA KUVVETİ

28 MM DELME KAPASİTESİ

0-900 ELEKTRONİK DELME AYARI

AKSESUARLI



**89,50 \$**

**MX8116 AVUÇ TAŞLAMA 115 MM**

650 WATT

220 VOLT

1200 DEVİR / DAKİKA

115 MM DİSK ÇAPI

**38,78 \$**



**MX7800 MİKSER**

1400 WATT

220 VOLT

0-900DEVİR / DAKİKA

140 MM MİKSER ÇAPI

**99,94 \$**

**MX 4187 DAİRESEL TESTERE**

1250 WATT

220 VOLT

185 MM TESTERE ÇAPI

63 MM KESME DERİNLİĞİ

**77,56 \$**





**QSB-JH-400 TEMİZ SU DALGIÇ POMPA**

400 WATT

700 LİTRE / SAAT

DAĞITIM YÜKSEKLİĞİ 8 METRE

EMME DERİNLİĞİ 7 METRE

PARTİKÜL BOYU 5 MM

10 METRE GÜÇ KABLOSU

**74,58 \$**



**QSB-JH-400B KİRLİ SU DALGIÇ POMPA**

400 WATT

700 LİTRE / SAAT

DAĞITIM YÜKSEKLİĞİ 8 METRE

EMME DERİNLİĞİ 7 METRE

PARTİKÜL BOYU 35 MM

10 METRE GÜÇ KABLOSU

**73,09 \$**

**RN6012 AKÜLÜ MATKAP**

12 V - 1,3 AMPER

ÇİFT AKÜ

TEK VİTES

18 KADEME TORK

0-700 DEVİR / DAKİKA

15 NM TORK

10 MM MANDREN

**52,21 \$**



**RN1010 DARBELİ MATKAP**

500 WATT

220 VOLT

0-3000 DEVİR / DAKİKA

13 MM MANDREN

**28,34 \$**

**RN2020 AVUÇ TAŞLAMA**

500 WATT

220 VOLT

11000 DEVİR / DAKİKA

115 MM DİSK ÇAPI



**28,34 \$**



